



Circulation Pump

Master SD
Mega
Mega S
Instant

Instant E
Instant S
Instant hot water
Aquamaster

Basic S
Basic
Promo

1. Circulator pumps overview

2. Master SD circulator pump

- Type key
- Application
- Operating conditions
- Construction
- Performance curves and technical data
- Dimensions

3. Mega circulator pump

- Type key
- Application
- Operating conditions
- Construction
- Electric control instructions
- Performance curves and technical data
- Dimensions

4. Mega circulator pump

- Type key
- Application
- Operating panel
- Electric control instructions
- Construction
- Performance curves and technical data
- Dimensions

5. Mega S circulator pump

- Type key
- Application
- Electric control instructions
- Operating conditions
- Construction
- Performance curves and technical data
- Dimensions

6. Instant circulator pump

- Type key
- Application
- Operating conditions
- Construction
- Performance curves and technical data
- Dimensions

7. Instant S circulator pump

- Type key
- Application
- Operating conditions
- Construction
- Performance curves and technical data
- Dimensions

8. Instant hot water circulator pump

- Application
- Operating conditions
- Electric control instructions
- Performance curves and technical data
- Dimensions

9. Aquamaster booster pump

- Application
- Operating conditions
- Electric control instructions
- Construction
- Performance curves and technical data
- Dimensions

10. Basic S circulator pump

- Type key
- Application
- Operating conditions
- Construction
- Material specification
- Performance curves and technical data
- Dimensions











11. Basic circulator pump

- Type key
- Application
- Operating conditions
- Installation
- Construction
- Product range
- Performance curves and technical data
- Dimensions

12. Promo compact pressure booster pump

- Type key
- Application
- Operating conditions
- Construction
- Operating modes
- Performance curves and technical data

1. Circulator pumps overview

Application	Pump type									
										
	Master SD	Mega	Mega S	Instant Instant E	Instant S	Instant hot water	Aquamaster	Basic S	Basic	Promo
Radiator systems	•	•	•	•	•			•	•	
Underfloor heating systems								•	•	
Domestic hot water circulation	•			•	•					
Solar-heating systems	•	•								
Compliance with European energy efficiency requirements EUP 2015	•	•	•							
Boosting of hot or cold water supply				•	•	•				•

Conditions to measure performance

Instructions below are valid for performance curves given in this section below.

- Degassed water was used as pumped liquid when measuring performance.
- Performance of the pumps designed for 1 x 230 V was measured with water temperature of +20 °C.
- All the values are approximate and do not guarantee that the pumps actually have the same performance. If it is necessary to calculate a minimum curve, an individual research is required.
- The given performance range is valid for kinematic viscosity of 1mm²/s (1 cSt).
- Transformation of hydrostatic head H [m] into pressure p [kPa] was performed for water with density ρ = 1,000 kg/m³. For pumped liquids with other densities, outlet pressure should be proportional to density.

How to select a pump: a brief instruction

Prior to selecting a pump, ensure that the following parameters comply with the operating conditions:

- quality and temperature of pumped liquid;
- environmental conditions;
- minimum inlet pressure;
- maximum operating pressure.

See section «Operating conditions»

Pump size

Pump sizes are selected according to the following parameters:

- required maximum flow in a hydraulic system (Q);
- maximum pressure losses in a hydraulic system (H).

In order to find a duty point, study the description of a certain pump size.

Put the required maximum flow (Q) on the X axis, maximum pressure losses (H) — on the Y axis. See Fig. 1.

Note: for more energy effective operation, selecting an excessive pump size is not recommended.

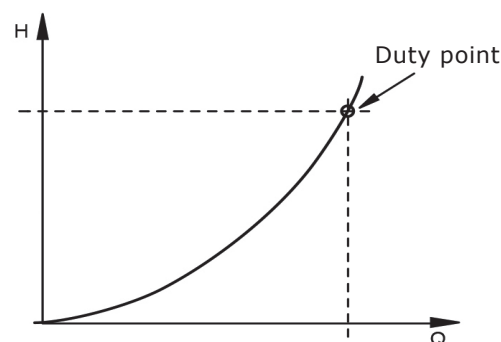

Fig. 1 System characteristic

Master SD automatic circulator pump



Fig. 1 Master SD pump

Type key

Master SD

Example	Master SD	25	-4	180
Type range	_____	_____	_____	_____
Nominal diameter of inlet and outlet ports (DN), [mm]	_____	_____	_____	_____
Maximum head [m]	_____	_____	_____	_____
Port-to-port length [mm]	_____	_____	_____	_____

Application

Master SD pumps are designed for circulation of water or liquids with glycol in heating systems, underfloor heating systems, air conditioning and cooling systems. Cooling systems include systems in which the temperature of pumped liquid is lower than ambient temperature.

- systems with weather-dependent automatics in which it is recommended to optimize the position of the pump duty point;
- systems with temperature variables in a pressure pipe.

Master SD pumps automatically adjust the pressure in the system according to an actual system requirement. An automatic pump operating mode can be used in all the circuits of a heating system: one- or two- pipe radiator circuits, underfloor heating circuits and feed boiler circuits.

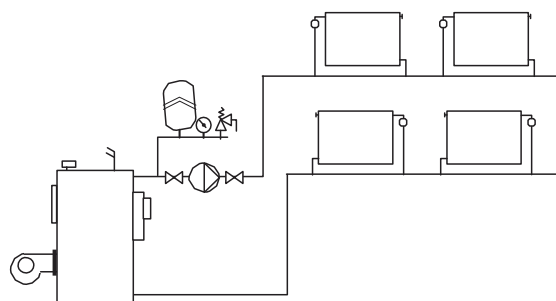

Fig. 2 One-pipe heating system

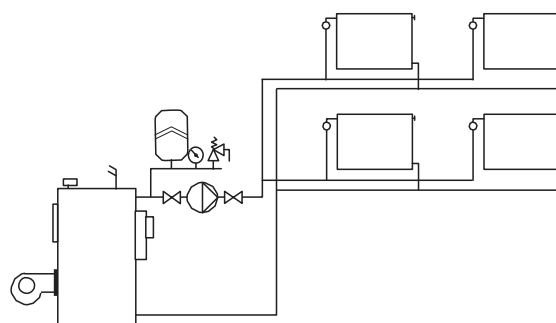

Fig. 3 Two-pipe heating system

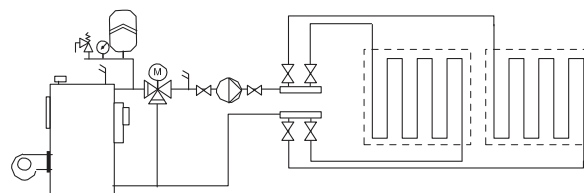

Fig. 4 Underfloor heating system

Below you can find the table with the data to select a pump for a certain heating system.

House area [m ²]	Flow in the heating system at $\Delta t = 15\text{ }^{\circ}\text{C}$ [m ³ /h]	Flow in the underfloor heating system at $\Delta t = 5\text{ }^{\circ}\text{C}$ [m ³ /h]	Pump type
60-80	0.5	1.5	XX-4
80-120	0.7	2	XX-6
120-150	0.9	2.5	XX-7
180-200	1.1	3.2	XX-8

The recommendations are for information only.

Operating conditions

Master SD circulator pumps can be used with the following liquid types:

- pure, non-viscous, non-corrosive, non-flammable, and non-explosive liquids without solids or fibers;
- cooling liquids without mineral oils;
- softened water.

Kinematic water viscosity = 1 mm²/s (1 cSt) at 20 °C. When a circulator pump is used to pump a more viscous liquid, performance of the hydraulic system decreases. Exclude additives that can negatively effect pump operation. The pump should be selected according to pumped liquid viscosity.

Technical data

Supply voltage	230V +10% -15%,50Hz,PE
Motor protection	Additional external protection is not required
Protection against water and dust	IP44
Insulation class	H
Relative air humidity	Max. 95 %
Ambient temperature	From -30 to +70 °C
Sound pressure	≤ 42 dB(A)
Temperature class	TF110
System pressure	Maximum 1.0 MPa (10 bar)
Liquid temperature	-20 ... +110 °C

Inlet pressure

To avoid cavitation noise and pump bearings damage, the following minimal pressure should be set up for an inlet port:

Liquid temperature	≤75 °C	95 °C	110 °C
Inlet pressure	0.5 m 0.05 bar	5 m 0.5 bar	10.8 m 1.08 bar

Electric control instructions

Necessity in the heating intensity of each room constantly changes and depends significantly on solar activity, time of the day, and individual features of the rooms heated.

These are the reasons why a non-adjustable pump can not adapt to changing conditions and works inefficiently. Possible consequences when using non-adjustable pumps:

- excessive pressure in the system;
- noise in thermostatic heads;
- manual control of the heating system;
- excessive electricity consumption

Adjustable pumps equipped with a frequency converter and integrated software can process an actual system enquiry and automatically adjust to changing conditions.

Operation principles of non-adjustable and adjustable pumps are compared in the following graphs:

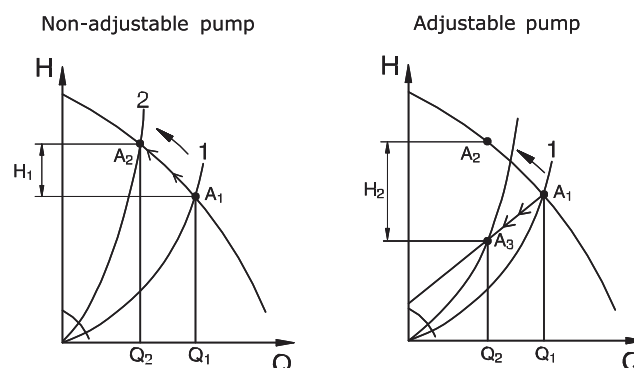
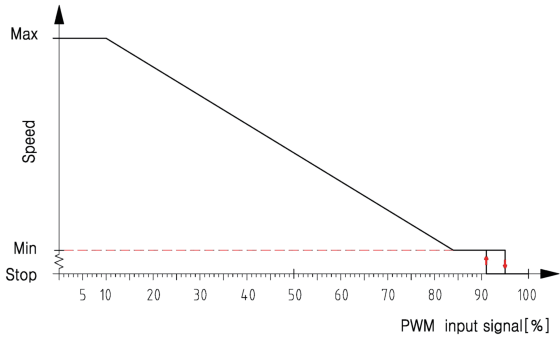

Fig. 5 Changing of the duty point position of an adjustable and non-adjustable pump

If the system adopts a non-adjustable pump, then when thermostatic valve tap is closed, pressure difference on it increases due to the pump head rise in a low performance area. This increased pressure difference on the valve tap leads to local increase in water speed that, therefore, causes an unpleasant cavitation noise. If the system involves a Master SD pump, the head before the valve tap will drop as the supply of the pump decreases. It means that the reason for noise appearance will be eliminated and the supply of heat transfer medium will comply with the real requirement of the system. Also, as the head decreases, a Master SD pump decreases energy consumption.

PWM 1 signal input

Under fixed frequency, different duty cycles correspond to different motor given speed signals. Inverse proportional control mode is adopted. The specific control logic is as follows:



PWM1 Input Signal (%)	Pump Status
≤10	the pump runs at the highest velocity
>10/≤84	the pump curve will drop from the highest to the lowest
>84/≤91	the pump runs at the lowest velocity
>91/<95	if the velocity variance point of input signal fluctuates, then it will block the start and stop of the pump according to the principle of magnetic hysteresis
≥95/≤100	stand-by, the pump stops
Recognition accuracy	±1 (Example: When the PWM input signal is 20%, the actual duty cycle is in the range of 19%-21%)

PWM 2 signal input

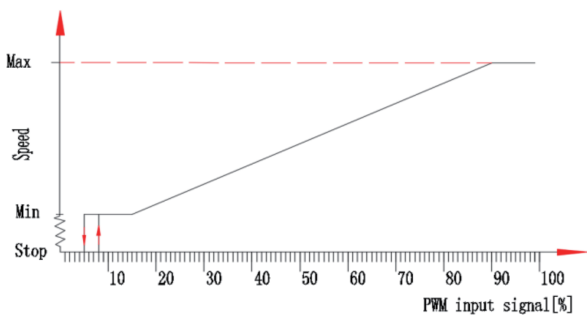

PWM2 Input Signal (%)	Pump Status
≤5	Gear display: 5 lights are fully on, indicating that it is in PWM2 mode. Pump status: standby, the pump stops running (the signal line is not connected to the PWM signal, and the pump also stops running)
>5/ <8	If the input signal fluctuates near the speed change point, the pump is prevented from starting and stopping according to the hysteresis principle
≥8/ ≤15	The water pump operates at the lowest speed
>15/ ≤90	The pump rises linearly from the lowest to the highest
>90/ ≤100	the pump is running at the highest speed
Recognition accuracy	±1 (Example: When the PWM input signal is 20%, the actual duty cycle is in the range of 19%-21%)

PWM input signal	parameter
Current isolation in pump	YES
Frequency input	100 ~ 4000 Hz
Input voltage high level	4.0 ~ 24 V
Input voltage low level	≤ 0.7V
Input current high level	Max 10 mA@100ohms
Input PWM duty cycle	0 ~ 100 %
Signal polarity	Fixed changeless
Rise time	≤ T/500

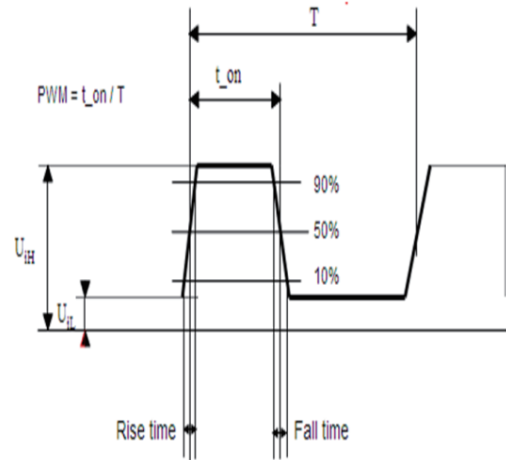

PWM feedback

Frequency range: 75±5%Hz.
Corresponding relationship between output signal and circulating pump and operating status.

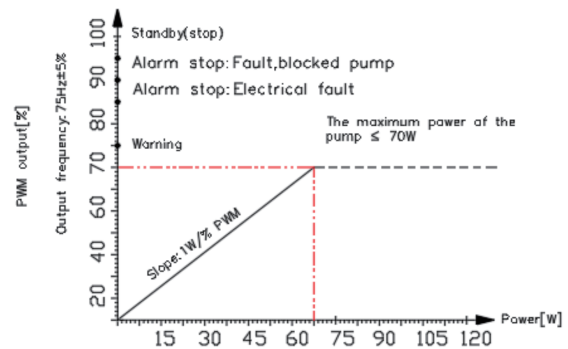

PWM output signal (%)	State	Potential causes
95	Standby (stop)	The pump stops
90	Alarm shutdown, fault (pump stuck) (locked rotor protection)	The water pump does not operate. After the fault disappears, the water pump will operate again.
85	Alarm shutdown, electrical fault (light load protection, phase loss protection, overcurrent protection, over temperature protection, etc.)	The water pump does not run, and the water pump will run again after the fault disappears; Remarks: light load protection. After the cumulative number of protection reaches 5 times, it will not be restarted, and it needs to be powered on again for operation.
75	Warning (overvoltage protection and undervoltage protection)	The water pump does not operate. In this case, the fault has been detected, but the fault is not critical. It can still work normally after the protection value is restored.
0-70	0-70W(slope 1 W/% PWM)±1%	
Recognition accuracy:±1(Example: When the PWM input signal is 20%, the actual duty cycle is in the range of 19% ~ 21%)		

Construction

Master SD pumps are of the canned-rotor type. In these pumps, the rotor of the motor is washed by pumped liquid.

Water in such pumps is used to:

1. Lubricate the bearings of an motor and remove wear debris.
2. Cooling of the stator winding.

Construction advantages of Master SD pumps:

- An energy-efficient brand new permanent-magnet motor and increased starting torque.
- A ceramic shaft and bearings with the same temperature extension coefficient provide increased reliability of the equipment.
- A thrust bearing is made of carbon that extends the service life of the pump.
- A rotor can and thrust bearing are made of stainless steel to resist corrosion.
- The pump housing is made of cast iron with protective stainless steel anti-rust coating.
- Simplified pump connection to power supply with a plug.

This design adopts a four-pole synchronous permanent-magnet motor and frequency converter. Easy access to the terminal box and cable tension compensator are included. The motor complies with the Low Voltage Directive (EN 60335-2-51). The motor is protected from short circuits.

The motor is protected by electronics of the control unit and does not require any external protection. The pump is connected to power supply via a plug supplied with it.

Material specification

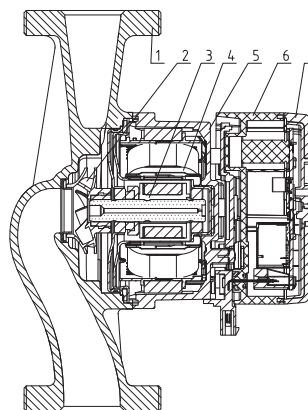

Fig. 6 Sectional drawing

No.	Name	Material
1	Pump housing	Cast iron with cataphoretic coating
2	Impeller	Composite
3	Assembled rotor	Stainless steel
4	Protective cover	Stainless steel
5	Stator housing	Aluminum alloy
6	Terminal box base	Composite
7	Terminal box cover	Aluminum alloy + composite

Product range

Pump model	Connection size	Port-to-port length mm	Rated power (W)	Rated current (A)	Voltage
Master SD 20-4	G 1"	130/180	25	0.25	230V
Master SD 20-5			33	0.3	230V
Master SD 20-6			39	0.35	230V
Master SD 20-7			52	0.45	230V
Master SD 20-8			70	0.55	230V
Master SD 25-4	G 1 1/2"		25	0.25	230V
Master SD 25-5			33	0.3	230V
Master SD 25-6			39	0.35	230V
Master SD 25-7			52	0.45	230V
Master SD 25-8			70	0.55	230V
Master SD 32-4	G 2"		25	0.25	230V
Master SD 32-5			33	0.3	230V
Master SD 32-6			39	0.35	230V
Master SD 32-7			52	0.45	230V
Master SD 32-8			70	0.55	230V

Performance curves and technical data

Master SD 20/25/32-4 180

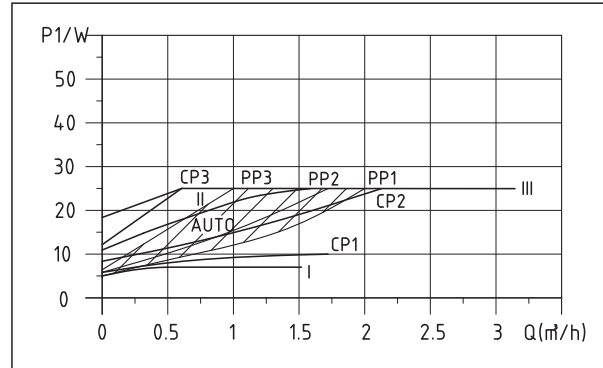
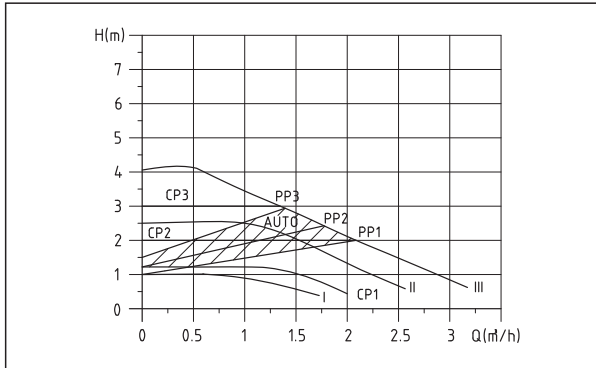

Master SD 20/25/32-5 180

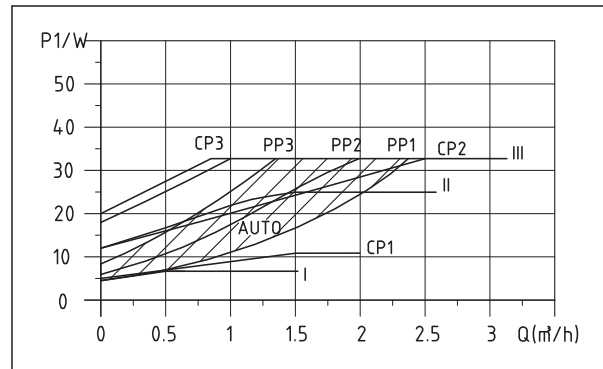
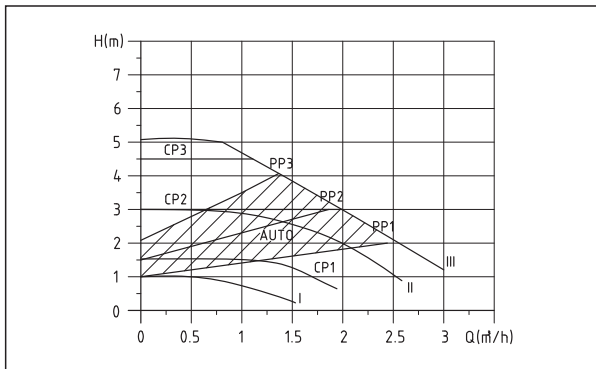

Master SD 20/25/32-6 180

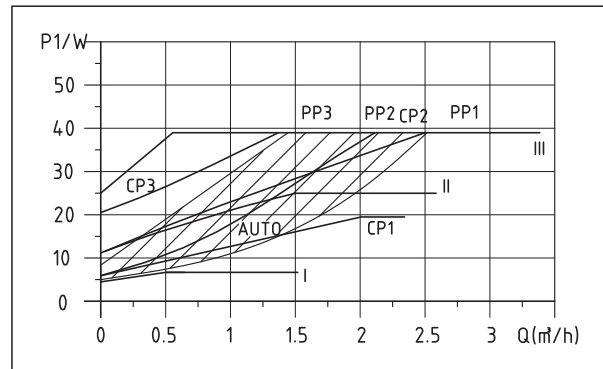
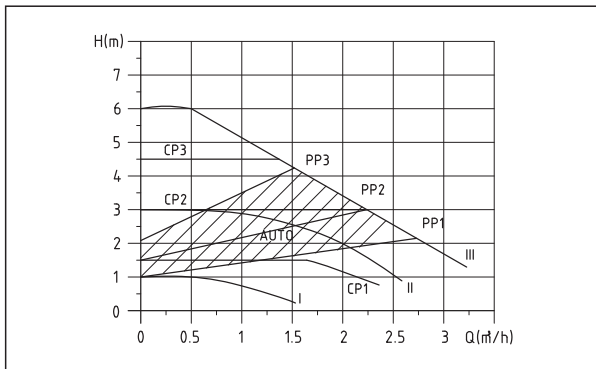

Master SD 20/25/32-7 180

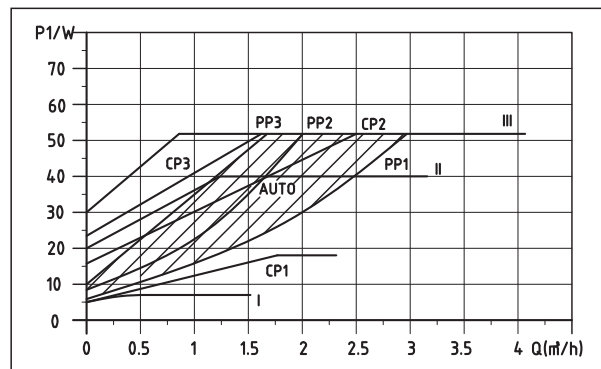
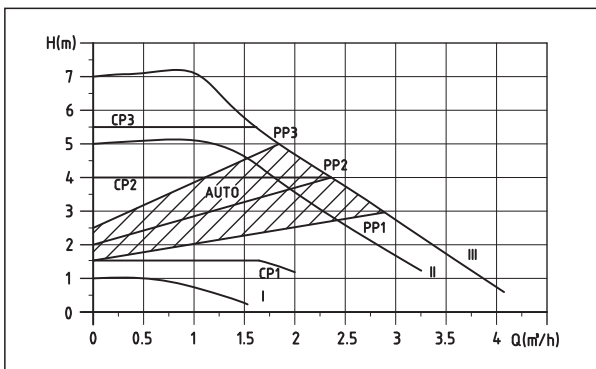

Master SD 20/25/32-8 180

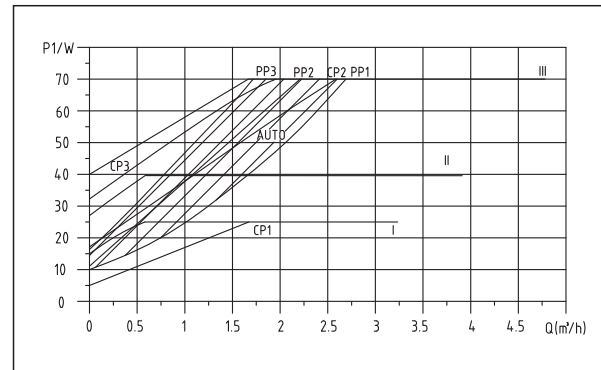
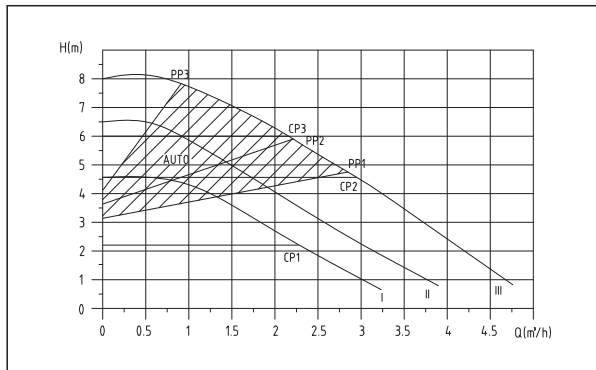

Dimensions

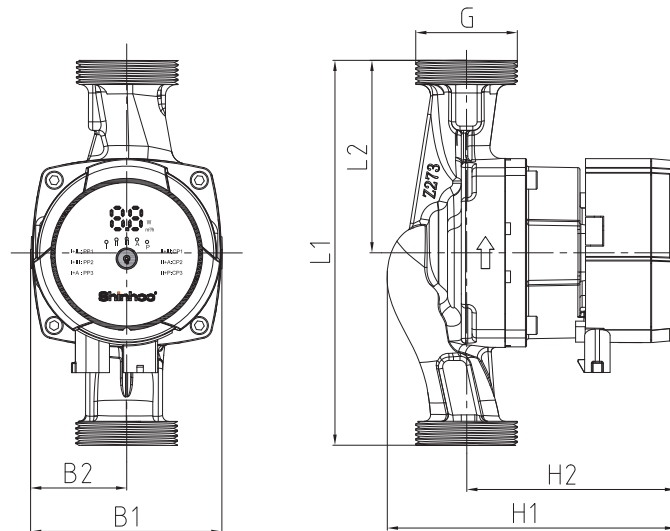

Fig.09

Pump model	Size [mm]						
	B1	B2	L1	L2	H1	H2	G
Master SD 20-X	90	45	130	65	135	90	1"
Master SD 25-X	90	45	130	65	135	90	1 1/2"
Master SD 25-X	90	45	180	90	135	90	1 1/2"
Master SD 32-X	90	45	180	90	135	90	2"

Mega automatic circulator pumps



Fig. 30 Mega pump

Type key

Example	Mega	40	-10	F	180
Type range					
Nominal diameter (DN) of inlet and outlet ports [mm]					
Maximum head [m]					
Flange configuration (if no marks, then threaded)					
Port-to-port length [mm]					

Application

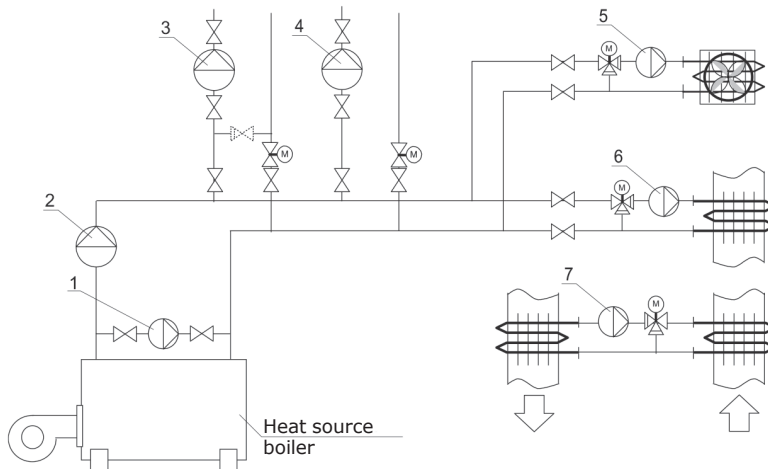

Fig. 31 Functional drawing of heating system

1. Boiler circuit pump
2. Primary circuit pump
3. Pump in one- and two-pipe heating systems
4. Heating circuit pump in a domestic hot water circulation
5. Heat pump in air heating systems
6. Pump for underfloor heating systems
7. Heat regeneration and recovery systems

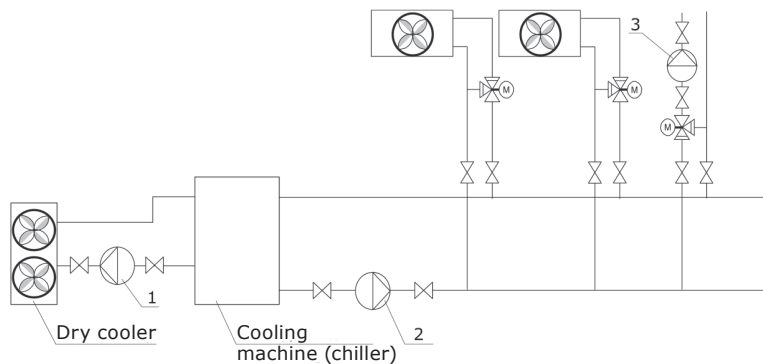

Fig. 32 Functional drawing of air conditioning system

1. Condenser and dry cooler circuit pump
2. Consumer circuit pump (fan coils)
3. Pump of cold supply systems in central air conditioners

Operating conditions

General instructions

Water in heating systems	Water quality according to local standards
Water with glycol	Maximum viscosity = 10–50 cSt ~ solution of water 50 % / glycol 50 % at -10 °C

Operation range

Parameter	MEGA
Maximum flow, Q	10 m ³ /h
Maximum head, H	10 meters

Liquid temperature

from 2 to +110 °C.

Environmental conditions

Ambient temperature when operated	from 0 to +40 °C
Ambient temperature when stored or transported	from -30 to +70 °C
Relative air humidity	Max. 95 %

Maximum operating pressure

PN 10: 10 bar / 1.0 MPa.

Minimum inlet pressure

In order to avoid cavitation noise and bearings damage during pump operation, the following minimum relative pressure should be maintained at its inlet port.

Inlet pressure	Liquid temperature	Inlet pressure of the pump
	≤ + 85 °C	0.005 MPa
	≤ + 90 °C	0.028 MPa
	≤ +110 °C	0.100 MPa

Note: the sum of actual inlet pressure and pump pressure when the valve is closed should always be lower than a maximum allowable operating pressure in the system.

Relative minimum pressure is given for the pumps installed at 300 m above the sea level. For the pumps installed higher than 300 m above the sea level, the required relative inlet pressure should be increased by 0.01 bar or 0.001 MPa per each 100 m of height. MEGA pumps are allowed only at a height up to 2,000 m above the sea level.

Sound pressure

Sound pressure depends on the power consumed and does not exceed 42 dB (A).

Pumped liquids

The pump is designed to pump pure and non-corrosive liquids without solids or fibers that can have a mechanical or chemical impact on the pump. Water used in heating systems should meet the quality requirements of system water for heating units.

The pumps must not be used for inflammable or explosive liquids such as diesel fuel or petrol.

The pumps must not be used for corrosive liquids such as acids or sea water.

If the pump is not operated during a cold season, take the necessary measures to avoid low temperature damages.

Using additives in a heat transfer medium with the density and/or kinetic viscosity higher than the water ones decreases the performance of the pump. Never use the additives that can negatively affect the pump operation.

In order to learn whether the pump can be used with a certain liquid, take into account several factors. The most important are lime content, pH, temperature, and the content of solvents and oils.

The pump can be used for glycol and water mixtures at the level up to 50 %.

Pumping of glycol mixtures decreases hydraulic properties of the pump.

Construction

Mega pumps are wet rotor pumps, i.e. the pump and the motor are a single-piece unit without shaft end seal. The bearings are lubricated with pumped liquid.

The pumps feature:

- controller built in a control unit;
- operating panel at the front of the pump;
- external protection of the motor is not required.

Motor and frequency converter

Mega pumps are equipped with permanent-magnet motor. This motor type is characterized by an increased efficiency in comparison with traditionally used asynchronous squirrel-cage motors.

Motor speed is set up by a built-in frequency converter.

Pump connections

Threaded pipe and flange connections.

Surface finish quality

A pump housing and its head part have cataphoretic coating for better corrosion resistance. Cataphoretic coating application includes the following steps:

- alkali cleaning;
- zinc phosphate pre-treatment;
- cathodic electrodeposition (cataphoresis);
- varnish-and-paint film drying at 200–250 °C.

Installation

Mega pumps are designed for indoor installation. The shaft of the pump should be installed horizontally.

The pump can be installed both on horizontal and vertical pipelines.

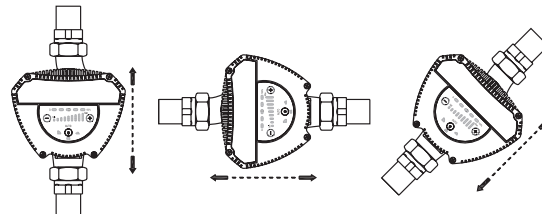

Fig. 33 Acceptable position of the pump shaft

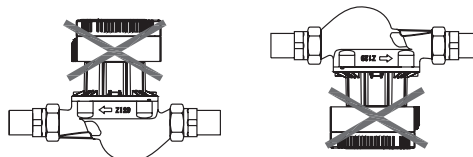

Fig. 34 Unacceptable position of the pump shaft

The arrow on the pump housing shows the direction of a liquid flow.

The control unit should be in a horizontal position.

The pump should be installed so that not to be exposed to the weight of the pipeline. The pump can be installed when suspended directly on the pipeline on condition that the pipeline has an appropriate load bearing capacity.

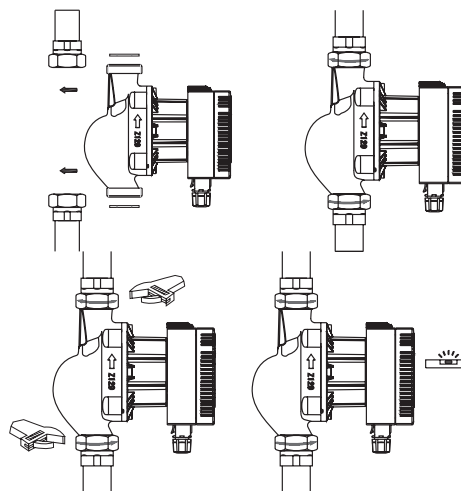

Fig. 35 Pump installation

In order to provide sufficient cooling of the motor and electronic equipment, fulfil the following requirements:

- The pump should be installed so that it can be cooled sufficiently.
- Ambient temperature should not be higher than 40 °C.

Electrical data

Pump type	Mega
Enclosure class (IP class)	IP 42
Insulation class	H
Supply voltage	1 x 230 V+10%,-15%, 50 Hz, PE
Digital input	PWM 0-10 V
Electromagnetic compatibility	EN61000-6-1 and EN61000-6-3

Electrical connection

Power supply connection should be performed in compliance with local regulations and rules.

- The pump should be connected to an external on/off switch.
- The pump should be appropriately earthed.
- External protection of the pump motor is not required.

Note: the pump should not be started and stopped more than four times within an hour when supply voltage is turned on and off.

The pump is connected to power supply according to Fig. 36.

Cables

All the cables should be connected in accordance with the local regulations.

Additional protection

If the pump is connected with an electric unit in which an electric switch (earth leakage circuit breaker - ELCB) is used as an additional protection, then it has to trip when earth fault currents with DC content (pulsating DC) occur.

The earth leakage circuit breaker should be marked with the first or both symbols given below:

Marking	Description
	High-sensitivity ELCB, type A, according to IEC 60775
	High-sensitivity ELCB, type B, according to IEC 60775

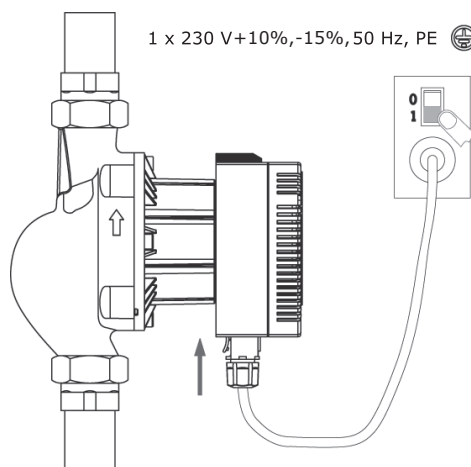
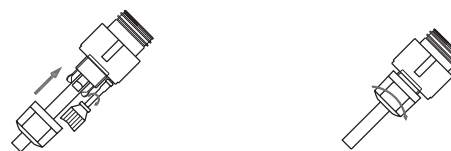
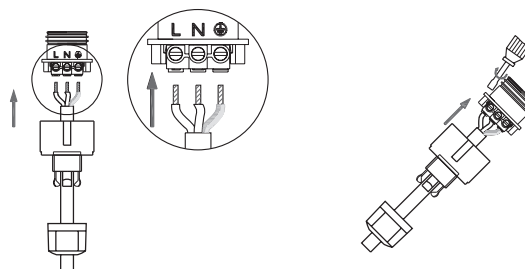
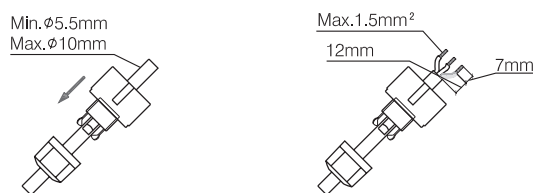

Fig. 36 Electrical connection

Electric control instructions

Control modes

The pump has 19 control modes with an automatically changed speed, nine modes with a constant speed and the mode controlled by an external controller with a PWM signal. The description of the modes is given below.

An operating mode should be adjusted according to the system type (see Fig. 37). Initial settings — AUTO (self-adjusting mode). Recommended settings of the pump are given in the table below.

You can select the control mode by pushing the button on the operating panel. (Fig. 41). The selected control mode will be visible due to light fields.

A	Underfloor heating system	AUTO	PD (1-9)
B	Two-pipe heating systems	AUTO	PR (1-9)
C	One-pipe heating systems	PP1	PD (1-9)

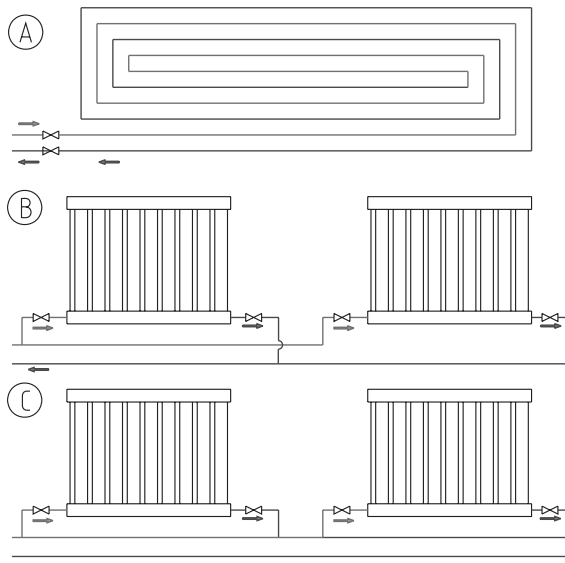

Fig. 37 Operating mode adjustment

Proportional pressure (PP1-9)

Proportional-pressure mode adjusts the pump performance to the actual heat demand in the system, but the pump performance follows the selected performance curve — PP1-9.

See Fig. 38.

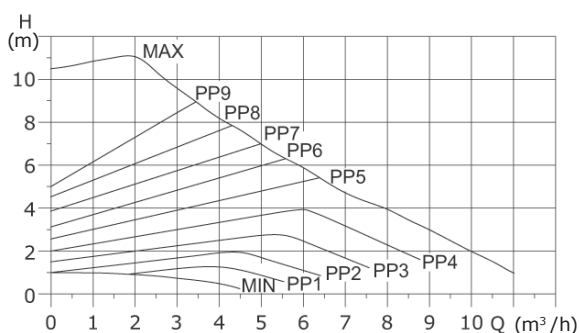

Fig. 38 Proportional-pressure curve settings

Depending on the pump unit sizes, there are 1-9 curves of the control mode of proportional pressure available.

The selection of the proportional pressure mode depends on the system parameters and required flow.

Constant pressure (CP1-9)

Constant pressure mode adjusts the pump performance with regard to the required flow in the system but within the selected performance curve — CP1-9. See Fig. 39 with CP1-9 modes.

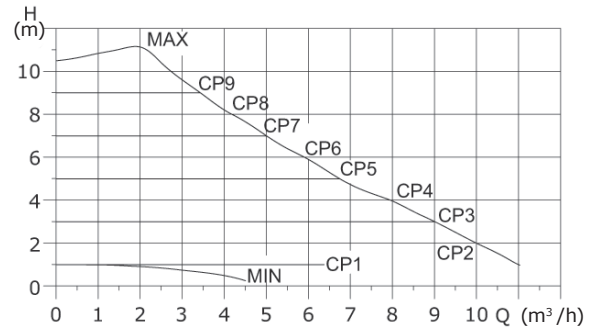

Fig. 39 Constant-pressure curve settings

Depending on the pump unit sizes, there are 1-9 constant pressure mode curves available.

The selection of the constant pressure mode depends on the system parameters and required flow.

Constant curve (CS1-9)

At constant curve, the pump runs at a constant curve independently of the actual flow demand in the system. The pump performance follows the selected performance curve — CS1-9. See Fig. 40

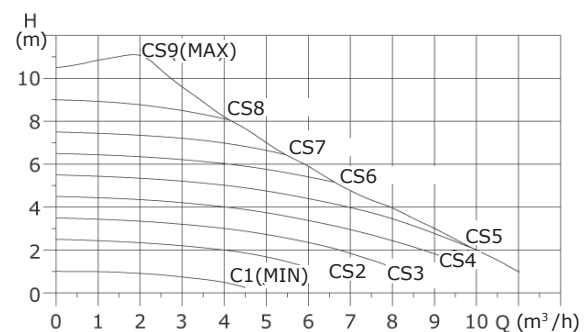

Fig. 40 Constant-curve settings

Depending on the pump unit sizes, there are 1-9 fixed speeds available.

The selection of a suitable operating mode at a constant curve mode depends on the system parameters and required flow.

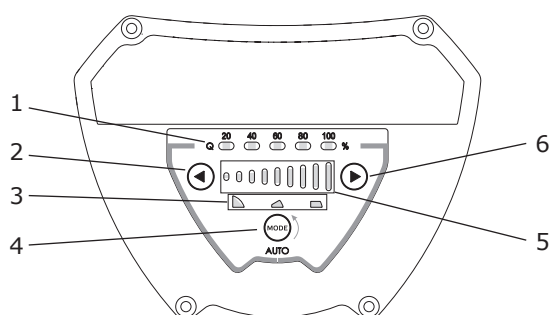

Fig. 41 Operating panel

No.	Description
1	Current flow, % of Max.
2	Speed decrease key
3	Operating mode indicators
4	Mode selection key
5	Speed increase key
6	Current operation speed indicator

PWM signal control mode

In order to transfer a PWM signal, use the supplied signal cable with a plug. The plug is connected to an appropriate connector of a control unit (see Fig. 42).

Procedure:

1. Disconnect the pump from the power supply.
2. Place the plug of a signal cable into a connector.
3. Connect the signal cable to an external controller.

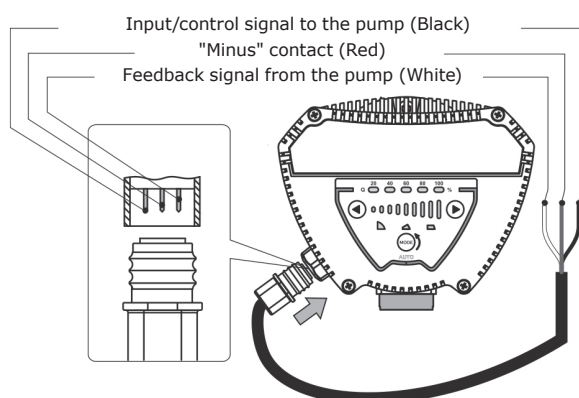

Fig. 42 Drawing of PWM signal connection

Brief description of control modes

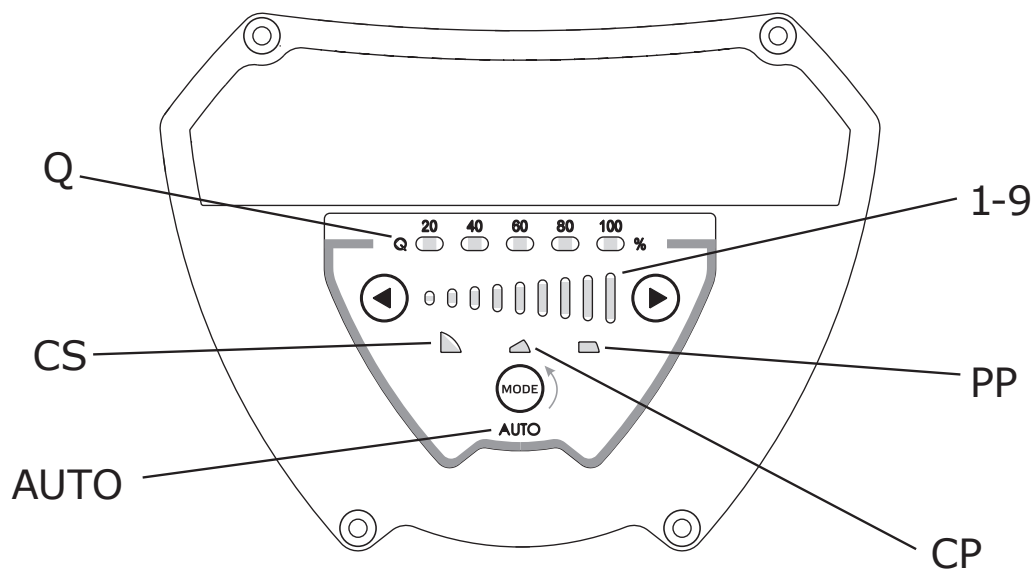

Fig. 43 Pump control modes

Setting	Pump performance curve	Purpose
PP1-5 for xx-6 model	Proportional pressure curves	The pump duty point will be shifted up or down along one of the five proportional pressure curves depending on the required system flow. The head (pressure) drops when the required flow in the system is reduced and rises when it is increased.
PP 1-7 for xx-8 model	Proportional pressure curves	The pump duty point will be shifted up or down along one of the seven proportional pressure curves depending on the required system flow. The head (pressure) drops when the required flow in the system is reduced and rises when it is increased.
PP 1-9 for xx-10 model	Proportional pressure curves	The pump duty point will be shifted up or down along one of the nine proportional pressure curves depending on the required system flow. The head (pressure) drops when the required flow in the system is reduced and rises when it is increased.
CP 1-5 for xx-6 model	Constant-pressure curves	The pump duty point will be shifted farther or closer along one of the five constant-pressure control mode curves depending on the required system flow. The head (pressure) remains constant regardless of the required flow in the system.
CP1-7 for xx-8 models	Constant-pressure curves	The pump duty point will be shifted farther or closer along one of the seven constant-pressure control mode curves depending on the required system flow. The head (pressure) remains constant regardless of the required flow in the system.
CP 1-9 for xx-10 models	Constant-pressure curves	The pump duty point will be shifted farther or closer along one of the nine constant-pressure control mode curves depending on the required system flow. The head (pressure) remains constant regardless of the required flow in the system.
CS1-5 for xx-6 models	Constant curves	The pump runs using one of the five constant performance curves, i.e. with constant speed.
CS1-7 for xx-8 models	Constant curves	The pump runs using one of the seven constant performance curves, i.e. with constant speed.
CS1-9 for xx-10 models	Constant curves	The pump runs using one of the nine constant performance curves, i.e. with constant speed.
Auto mode	Auto performance range	The pump duty point will be shifted up or down along one of the selected automatic curves depending on the required system flow. The head (pressure) drops when the required flow in the system is reduced and rises when it is increased. The pump automatically selects the curve independently; manual adjustment is not required.

Signal connection

PWM input(white), Fault feedback (red), 0~10V (green), ground cable (black)
 PWM output signal:pump feedback signal, PWM frequency is 75Hz±5%。

Interface circuit of PWM input signal

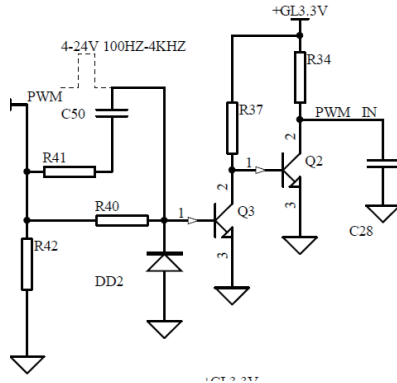

PWM output interface circuit

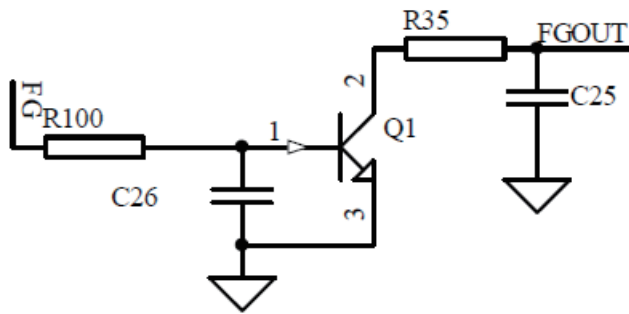

Electric control instructions

PWM signal input

Under fixed frequency, different duty cycles correspond to different motor given speed signals. Inverse proportional control mode is adopted. The specific control logic is as follows:

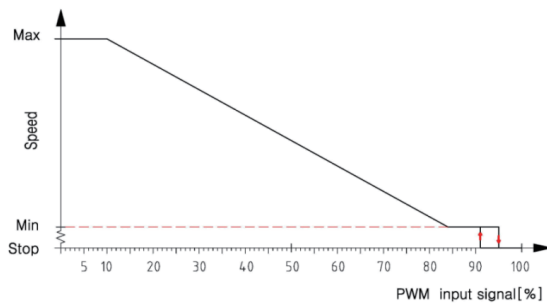

PWM input	Water pump status
0	Gear display: The factory default is AUTO. When the water pump is switched to non PWM mode (maximum speed operation), the system has no PWM signal by default.
≤10	The water pump operates at maximum speed.
>10 ~ ≤84	Pump linearity from highest to lowest.
>84 ~ ≤91	The water pump operates at the lowest speed.
>91 ~ ≤95	If the input signal fluctuates near the speed change point, the starting of the water pump will be prevented according to the hysteresis principle.
>95 ~ <100	Standby, the water pump stops running.
100	Gear display: The factory default is AUTO. When the water pump is switched to non PWM mode (maximum speed operation), the system has no PWM signal by default.

Accuracy: ±1 (Example: When the PWM input signal is 20%, the actual duty cycle is in the range of 19% ~21%)

PWM input signal	parameter
Current isolation in pump	YES
Frequency input	100 - 4000 Hz
Input voltage high level	4.0 - 24 V
Input voltage low level	≤ 0.7V
Input current high level	Max3.5mA@4700ohms Max10 mA@1000ohms
Input PWM duty cycle	0 - 100 %
Signal polarity	Fixed changeless
Rise time	≤ T/1000

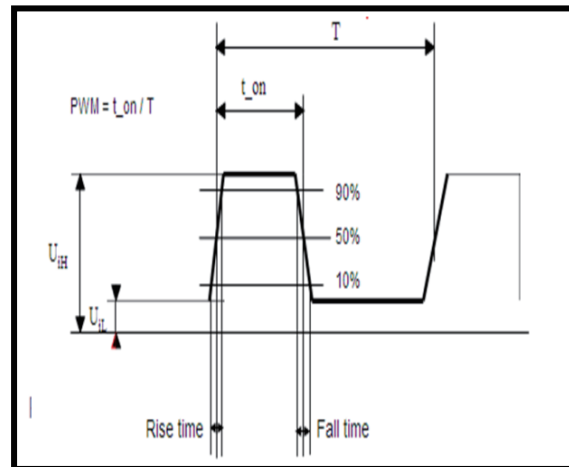

PWM feedback

Frequency range: 75±5%Hz.
 Corresponding relationship between output signal and circulating pump and operating status.

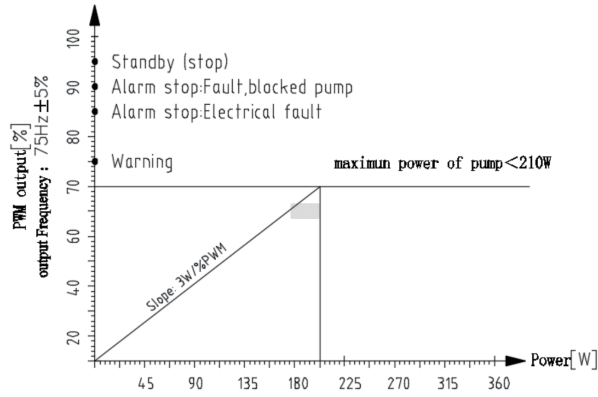

PWM Output signal (%)	Pump condition	Description
0-70	Pump operation	Power feedback: 0-185w (Slope: 3w/%PWM)
75	Alarm stop	The pump stops when the pump is in the state of overpressure or underpressure protection
85	Alarm stop	The pump is in the protection state of phased efficiency, over-current, over-temperature, etc., and the pump stops
90	Alarm stop	The pump stops when the pump is in the lock protection state
95	Bide one's time	/

Input signal (V)	Pump condition
$U < 1V$	Pump shutdown
$1V < U < 3V$	The pump runs at the lowest speed (when the analog voltage signal changes from large to small, when the voltage value is $< 1V$, the pump stops; $> 1V$, the pump runs at the lowest speed. When the voltage signal changes from small to large, when the voltage $< 2V$, the pump stops; $> 2V$, run at the lowest speed.)
$3V < U < 10V$	Pump at minimum and maximum speed (linear)
Remark	Once an analog voltage signal (0-10V voltage signal) comes in, the pump starts and directly enters the 0-10V mode; At this time, if the signal line is broken (including the signal line is not connected), the pump runs at the lowest speed, and the LED blinks.

0-10V Control logic

0-10V analog control signal description: The water pump starts to power on in conventional mode (constant speed mode or constant pressure mode or proportional mode or AUTO mode), and the factory default constant speed mode. Once there is 0 ~ 10V analog voltage input, the pump enters 0 ~ 10V analog control mode, in this mode, the input of different analog voltages, the pump is in different operating states, if the cable line is broken in this mode, the pump runs at the lowest speed (0 ~ 10V analog control mode, the lowest speed). Once the pump enters the 0-10V analog control mode, it cannot switch to the normal mode. If you want to enter the normal mode again, you must power on the pump again to enter the normal mode.

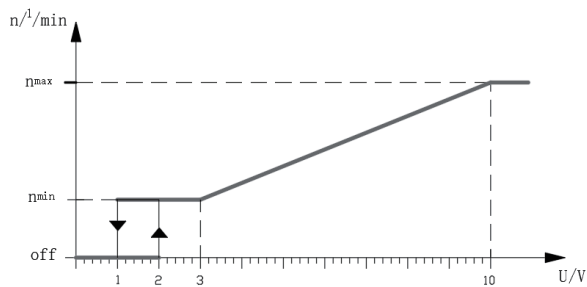

Recommendations on the control mode selection

Application in hydraulic systems	Control method:
<p>In systems with relatively large pressure losses in the distribution pipes and in air conditioning and cooling systems.</p> <ul style="list-style-type: none"> Two-pipe heating systems with thermostatic valves and: <ul style="list-style-type: none"> with very long distribution pipes; with strongly throttled pipe balancing valves; with differential-pressure regulators; with large pressure losses in those parts of the system through which the total quantity of water flows (for example, boiler, heat exchanger and distribution pipe up to the primary circuit). Primary circuit pumps in systems with large pressure losses in the primary circuit. Air conditioning systems <ul style="list-style-type: none"> with heat exchangers (fan coils); with cooling ceilings; with cooling surfaces. 	<p>Proportional pressure</p>
<p>In systems with relatively small pressure losses in the distribution pipes.</p> <ul style="list-style-type: none"> Two-pipe heating systems with thermostatic valves: <ul style="list-style-type: none"> dimensioned for natural circulation; with small pressure losses in those parts of the system through which the total quantity of water flows (for example, boiler, heat exchanger and distribution pipe up to the primary circuit); with high differential temperature between flow pipe and return pipe (for example, central heating). Underfloor heating systems with thermostatic valves. One-pipe heating systems with thermostatic valves or pipe balancing valves. Primary circuit pumps in systems with small pressure losses in the primary circuit. 	<p>Constant pressure</p>
<p>The pump can also be set to operate according to the maximum or minimum curve, i.e. to the mode similar to the operation of a non-adjustable pump:</p> <ul style="list-style-type: none"> The maximum curve mode can be used in periods in which a maximum flow is required. The minimum curve mode can be used in periods in which a minimum flow is required. 	<p>Constant speed</p>

Product range

Pump model	Connection size	Port-to-port length, mm	Rated power min/max, (W)	Rated current min/max, (A)	Voltage
					230 V
Mega 25-8	G 1 1/2"	180	10-130	0.09/0.9	•
Mega 25-10		180	10-185	0.09/1.25	•
Mega 32-8	G 2"	180	10-130	0.09/0.9	•
Mega 32-10		180	10-185	0.09/1.25	•
Mega 40-8F	DN40	220	10-130	0.09/0.9	•
Mega 40-10F	DN40	220	10-185	0.09/1.25	•

Performance curves and technical data

Mega XX-8

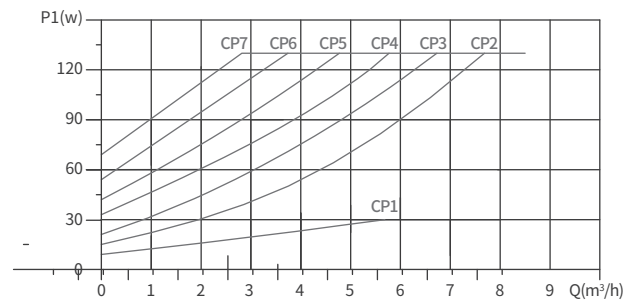
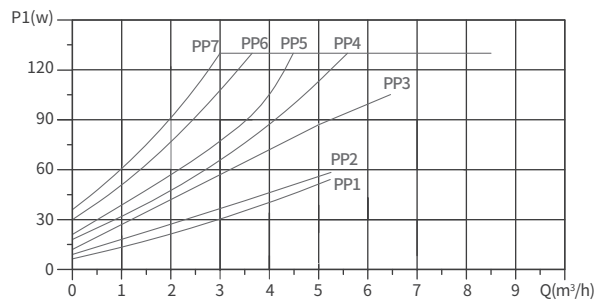
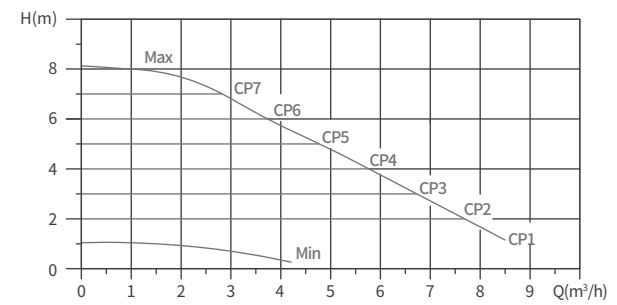
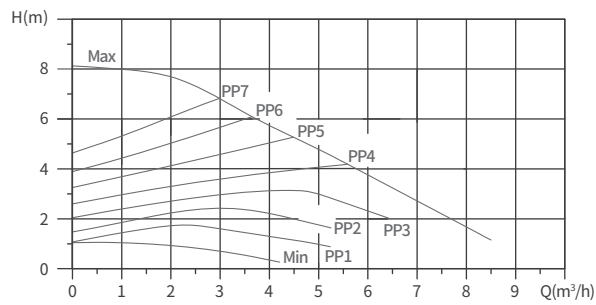
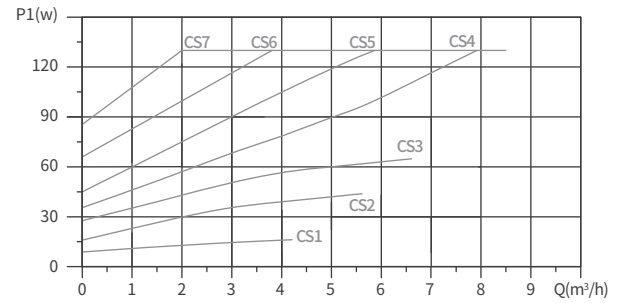
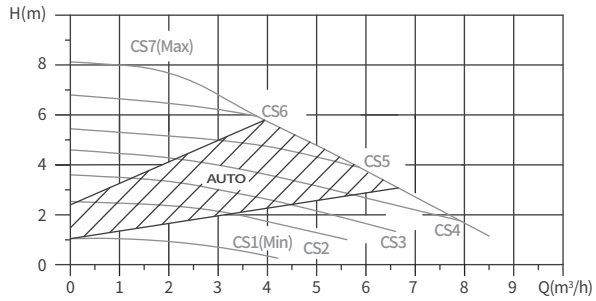

Mega XX-10

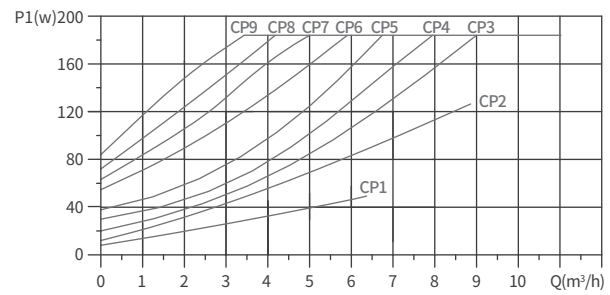
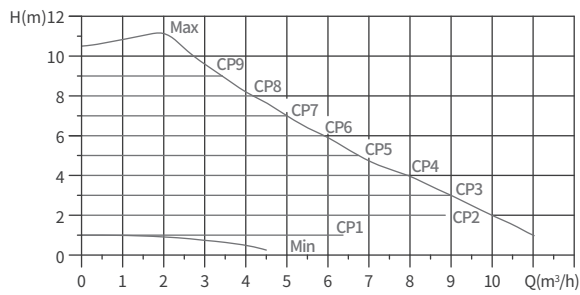
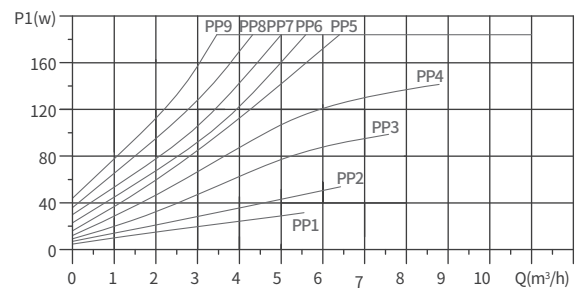
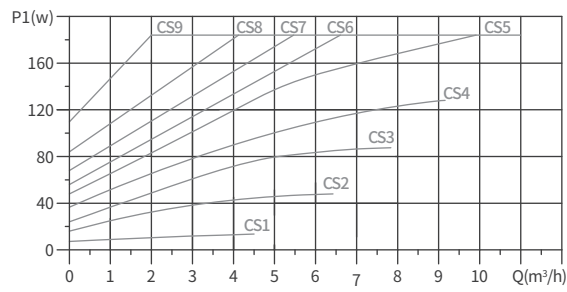
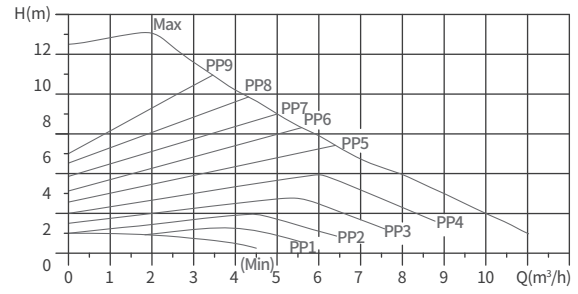
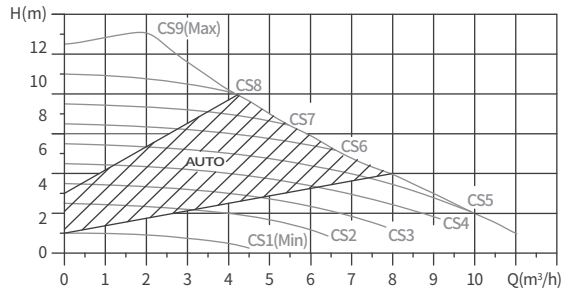

Dimensions

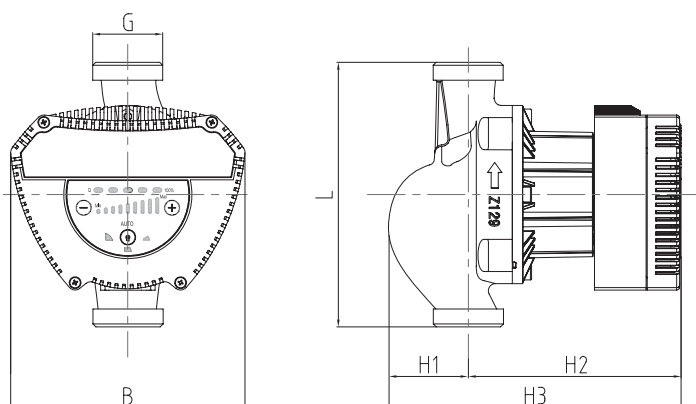

Pump model	Size [mm]					
	L	B	H1	H2	H3	G [inch]
Mega 25-8	180	160	55	144	199	G 1 1/2
Mega 25-10						G 2
Mega 32-8						
Mega 32-10						

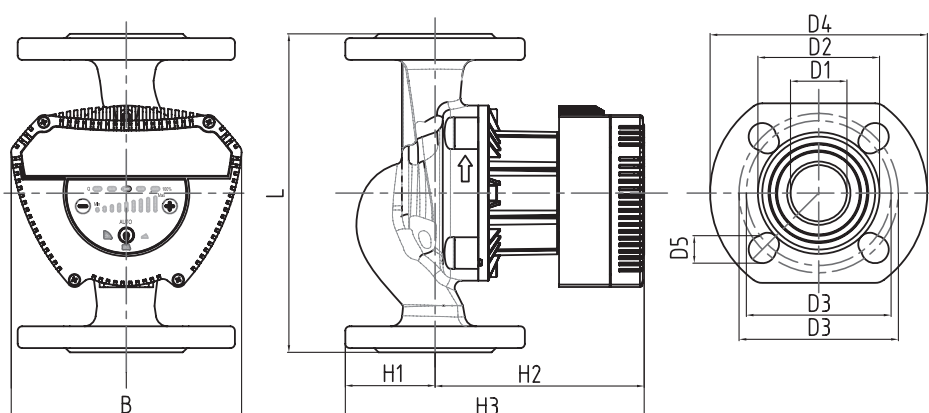

Pump model	Pump dimensions [mm]						Flange dimensions [mm]				
	L	B	H1	H2	H3	G [inch]/DN	D1	D2	D3	D4	D5
Mega 40-8F	220	160	62	144	206	DN40	40	84	100/110	150	19
Mega 40-10F	220	160	62	144	206	DN40	40	84	100/110	150	19

Mega S automatic circulator pumps



Fig. 44 Mega S pump

Application

- Heating systems:
 - main pump,
 - secondary circuit lines,
 - heating surfaces.
- Cooling and air conditioning systems;
- Ground source heat systems;
- Solar energy systems.

Mega S circulator pumps are highly effective both in new systems and as a replacement to the ones being in use. The pump is ideal for systems with an automatic pressure adjustment. These pump series allow avoiding the use of expensive bypass valves and similar components.

Type key

Example	Mega S	50	-18	F	280
Product type Mega S	_____				
Nominal diameter (DN) of inlet and outlet ports [mm]	_____				
Maximum head [m]	_____				
Flange configuration (if no marks, then threaded)	_____				
Port-to-port length [mm]	_____				

Operating panel

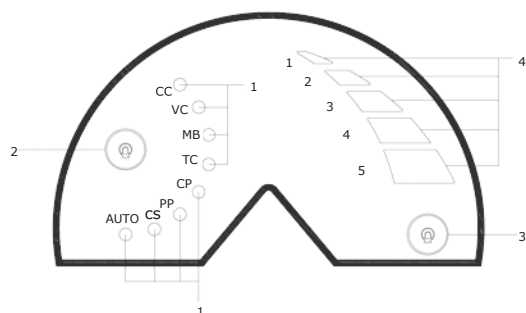

No.	Description
1	Light indicators of a pump operating mode
2	Control mode switch
3	Speed switch
4	Speed light indicator

Number of mode switch presses	Setting	Purpose
0 (pre-installed by default)	AUTO Mode	The pump duty point will be shifted up or down along one of the selected automatic curves depending on the required system flow. The head (pressure) drops when the required flow in the system is reduced and rises when it is increased. The pump automatically selects the curve independently; manual adjustment is not required.
1	CS 1-3	The pump works using one of the three constant curves, i.e. with constant rotational frequency.
2	PP 1-3	The pump duty point will be shifted up or down along one of the three curves of the control mode of proportional pressure alteration depending on the required system flow. The head (pressure) drops when the required flow in the system is reduced and rises when it is increased.
3	CP 1-2	A duty point of the pump will be shifted farther or closer along one of the two constant-pressure control mode curves depending on the required system flow. The head (pressure) remains constant regardless of the required flow in the system.
4	TC 1-10	The pump can change its operation status any time according to one of the five different temperature scales.
5	MB	Data transfer module via Modbus.
6	VC	The pump adjusts its rotational speed according to the range of an analog input signal level 0-10V.
7	CC	The pump adjusts its rotational speed according to the range of an analog input signal level 4-20 mA.

Electric control instructions

Brief description of control modes

<p>AUTO</p> <ul style="list-style-type: none"> • Recommendations for most heating systems. • During operation, the pump makes automatic adjustment according to an actual system characteristic. 	
<p>Proportional pressure</p> <ul style="list-style-type: none"> • Used in the systems with relatively significant pressure losses in distribution pipes. • The head of the pump will increase proportionally to the flow in the system in order to compensate high pressure losses in distribution pipes. 	
<p>Constant pressure</p> <ul style="list-style-type: none"> • It is advisable to use this control mode in systems with relatively low pressure losses. • The pump maintains constant head that does not depend on the flow in the system. 	
<p>Constant temperature</p> <p>In systems with a fixed curve, you should adjust the pump according to a constant temperature in the return pipe.</p>	
<p>Temperature difference</p> <ul style="list-style-type: none"> • Provides constant temperature difference in heating and cooling systems. • The pump supports constant temperature difference between the pump and an external sensor. 	
<p>Constant speed</p> <ul style="list-style-type: none"> • The pump can be switched to operating mode when rotational frequency is fixed, i.e. the mode similar to the operation of a non-adjustable pump. • Required rotational frequency can be adjusted in % of maximum rotational frequency in the range from minimum to 100 %. 	

Operating modes

Normal

The pump works in accordance with a selected control mode.

Note: a control mode and set value can be selected even if the pump does not work in a Normal mode.

Stop

The pump stops.

Minimum curve

The minimum-curve operating mode should be selected when you need minimum flow.

This operating mode can be used, for example, for manual switch to a night mode.

A minimum curve can be corrected by determining the pump operation range.

Maximum curve

The operating mode according to a maximum curve should be selected when the maximum flow is required.

Operating modes can be set directly with integrated digital codes. A maximum curve can be corrected by determining the pump operation range.

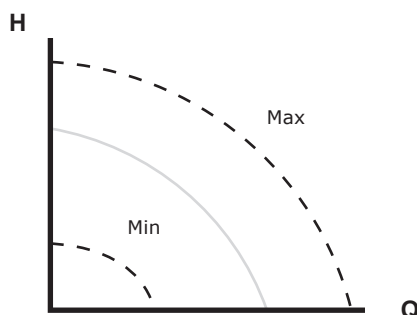

Fig. 45 Maximum and minimum curves

Control modes

Default settings

The pumps are supplied with factory settings in an AUTO mode that suits most systems.

The value is set by the manufacturer.

AUTO

We recommend an AUTO control mode for most heating systems, in particular, the ones with relatively significant pressure losses in distribution pipes as well as in case of replacement where the duty point is unknown for the proportional pressure mode.

This control mode is designed specially for heating systems. Application in air conditioning and cooling systems is not recommended.

Features and main advantages

- The pump makes automatic adjustment according to an actual system characteristic.
- Provides minimum energy consumption and low noise.
- Decreases operation expenses and increases comfort.

Proportional pressure

Proportional pressure adjustment suits the systems with relatively large pressure losses in distribution pipes and air conditioning and cooling systems:

- Two-pipe heating systems with thermostatic valves and:
 - with very long distribution pipes;
 - with strongly throttled pipe balancing valves;
 - with differential-pressure regulators;
 - with large pressure losses in those parts of the system through which the total quantity of water flows (for example, boiler, heat exchanger and distribution pipe up to the first branching).

- Primary circuit pumps in systems with large pressure losses in the primary circuit.
- Air conditioning systems:
 - with heat exchangers (fan coils);
 - with cooling ceilings;
 - with cooling surfaces.

Features and main advantages

- The pump head increases proportionally to the system flow.
- It compensates significant pressure losses in distribution pipes.

Specifications

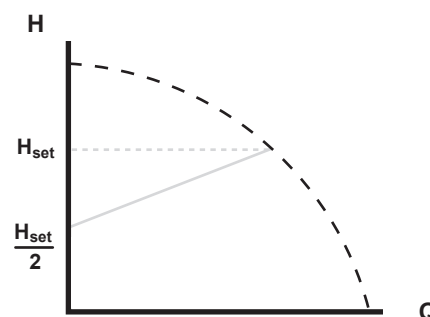

Fig. 46 Proportional pressure adjustment

When the valve is closed, the head is equal to a half of a set value H_{set} .

Constant pressure

Constant pressure adjustment suits the systems with relatively small pressure losses in distribution pipes:

- Two-pipe heating systems with thermostatic valves:
 - in natural circulation systems;
 - with small pressure losses in those parts of the system through which the total quantity of water flows (for example, boiler, heat exchanger and distribution pipe up to the first branching);
 - redesigned to a more significant temperature difference between flow pipe and return pipe (for example, for central heating).
- Underfloor heating systems with thermostatic valves.
- One-pipe heating systems with thermostatic or balancing valves.
- Primary circuit pumps in systems with small pressure losses in the primary circuit.

Features and main advantages

- The pump maintains constant flow that does not depend on flow in the system.

Specifications

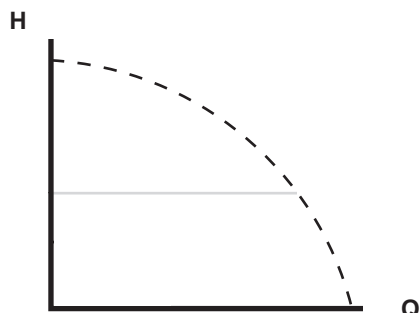

Fig. 47 Adjustment based on constant pressure

Constant temperature

This control mode is suitable for the systems with a fixed curve in which it is recommended to adjust the pump in accordance with a constant temperature in the return pipe.

The pump has a factory setting to work in a heating system with a controller gain coefficient $K_p=1$. If the pump is installed in a cooling system, the gain coefficient is necessary to be changed for a negative value, for example, -1. It can be completed with an operating panel.

Features and main advantages

- Constant temperature is maintained.

Specifications

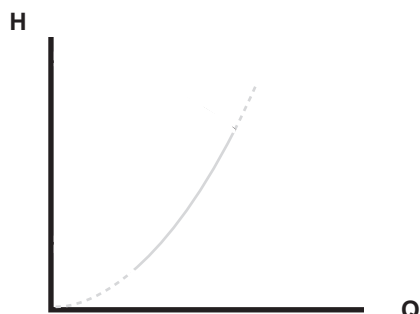

Fig. 48 Constant temperature adjustment

The mode of reverse control for cooling systems is available in the pumps starting from model B.

Temperature sensor

If the pump is installed in the flow pipe, it is required to install an external temperature sensor in the return pipe of the system.

See Fig. 49. The sensor should be installed as close as possible to the consumer device (radiator, heat exchanger, etc.).

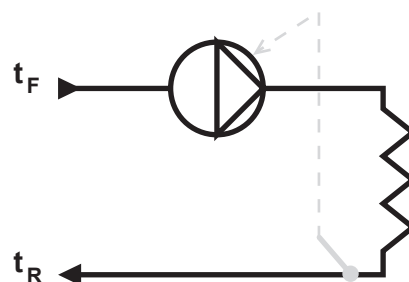

Fig. 49 Pump with an external sensor

If the pump is installed in the return pipe of the system, you can use a built-in temperature sensor. In this case, the pump should be installed as close as possible to the consumer device (radiator, heat exchanger, etc.).

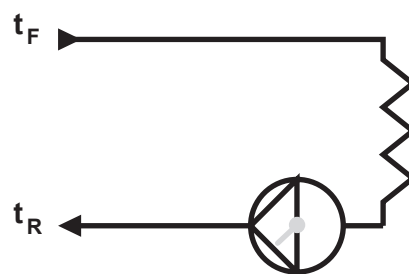

Fig. 50 Pump with a built-in sensor

Temperature difference

You should select this mode if pump performance is adjusted according to temperature difference in the system where the pump is installed.

Features and main advantages

- Provides constant temperature difference in heating and cooling systems.
- Maintains constant temperature difference between the pump and an external sensor, see Fig. 51.
- Two temperature sensors are required: a built-in temperature sensor and an external sensor.

Specifications

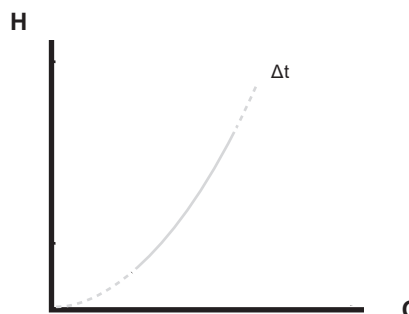

Fig. 51 Temperature difference

Temperature sensor

Built-in and external sensors are required to measure temperature difference in the flow and return pipes. If the pump is installed in the flow pipe, it is required to install an external temperature sensor in the return pipe and vice versa. The sensor should be installed as close as possible to the consumer device (radiator, heat exchanger, etc.).

Constant curve

Constant curve adjustment is applicable to the systems where constant flow and constant head are required, i.e.:

- heating surfaces;
- cooling surfaces;
- heating systems with 3-way valves;
- air conditioning systems with 3-way valves;
- pumps of the air conditioning system.

Features and main advantages

- If an external controller is used, the pump can be switched from one constant curve to another depending on an external signal value.
- The pump can be adjusted according to a maximum or minimum curve depending on your requirements.

Specifications

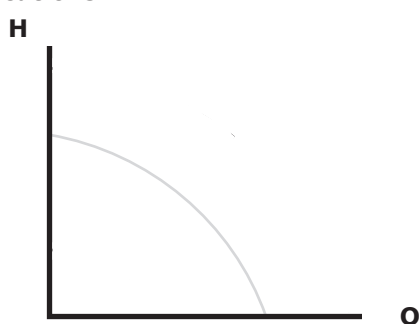

Fig. 52 Operation mode according to a constant curve

The pump can be switched to operation mode when rotational frequency is fixed, i.e. the mode similar to the operation of a non-adjustable pump. See Fig. 52.

You can set a required rotational frequency in % of the maximum frequency dependent on the pump model. The control range depends on the minimum rotational frequency, power limitation and pump pressure.

Note: if rotational frequency of the pump is set in the range between the minimum and maximum values, then the pump works according to its maximum curve; power and pressure are limited. It means that maximum performance can be reached at rotational frequency less than 100 %.

The pump can also be switched to the operating mode according to a maximum or minimum curve, i.e. to the mode similar to the operation of a non-adjustable pump:

- The operating mode according to a maximum curve should be selected when the maximum flow is required.

- The minimum-curve operating mode should be selected when you need minimum flow. For example, this operating mode can be used for manual switch to a night mode.

These modes can be selected via digital inputs.

4-20mA analog signal control

When the pump is in 4-20mA control mode, the pump adjusts the pump's operation according to the current range of the input analog signal.

Modbus communication control

When the electric pump is in Modbus control mode, the electric pump adjusts the running status of the pump according to the data collected by the communication.

10-Gear temperature control

When the pump is in temperature control mode, the pump can change its operating status at any time according to different temperature settings.

Operating conditions

General recommendations

Water in heating systems	Water quality according to local standards
Water with glycol	Maximum viscosity = 10-50 cSt ~ solution of water 50 % / glycol 50 % at -10 °C

Liquid temperature

Continuous pumping: from -10 to +110 °C.

Installation area

The pump is designed for indoor installation. The pump should be installed in dry conditions without the threat of soaking from nearby equipment, for example.

As the pump includes the stainless steel elements, installation is not recommended in the areas as follows:

- Indoor pools as the pump will be exposed to the pool environment.
- Areas with direct and long-term exposure to sea environment.
- Rooms where there are hydrochloric acid (HCl) fumes in the air, for example, as a result of leakage from tanks or frequent container opening and ventilation.

Cooling systems

In cooling system there can be condensation on the surface of the pump. In some cases tray installation is required.

Environmental conditions

Environmental conditions	
Ambient temperature when operated	from 0 to +40 °C
Ambient temperature when stored or transported	from -20 °C to +70 °C
Relative humidity	Max. 95 %

If ambient temperature is below 0 °C, the following conditions should be fulfilled:

- Liquid temperature: +5 °C.
- The pumped liquid contains glycol.
- The pump works and does not stop.

Minimum operating pressure

PN 10: 10 bar / 1.0 MPa

Test pressure

The pumps can withstand test pressure in accordance with EN 60335-2-51.

- PN 10: 12 bar / 1.2 MPa

In a normal operating mode, it is prohibited to use the pump at the pressure that exceeds the values written on a pump nameplate.

The test was conducted with the use of warm water at 20 °C with anti-rust additives.

Minimum inlet pressure

In order to avoid cavitation noise and bearings damage during pump operation, the following minimum relative pressure should be maintained at its inlet port.

Mega S	Liquid temperature		
	75 °C	95 °C	110 °C
	Inlet pressure [bar] / [MPa]		
Mega S 40-12F	0.90 / 0.09	1.40 / 0.14	2.0 / 0.20
Mega S 40-15F	0.90 / 0.09	1.40 / 0.14	2.0 / 0.20
Mega S 40-20F	0.90 / 0.09	1.40 / 0.14	2.0 / 0.20
Mega S 50-10F	0.70 / 0.07	1.20 / 0.12	1.7 / 0.17
Mega S 50-12F	0.70 / 0.07	1.20 / 0.12	1.7 / 0.17
Mega S 50-15F	0.70 / 0.07	1.20 / 0.12	1.7 / 0.17
Mega S 50-18F	0.70 / 0.07	1.20 / 0.12	1.7 / 0.17
Mega S 65-8F	0.70 / 0.07	1.20 / 0.12	1.7 / 0.17
Mega S 65-10F	0.70 / 0.07	1.20 / 0.12	1.7 / 0.17
Mega S 65-12F	0.70 / 0.07	1.20 / 0.12	1.7 / 0.17
Mega S 80-6F	0.80 / 0.08	1.30 / 0.13	1.90 / 0.19
Mega S 80-8F	0.80 / 0.08	1.30 / 0.13	1.90 / 0.19

Note: the sum of actual inlet pressure and pump pressure when the valve is closed should always be lower than the maximum allowable operating pressure in the system.

Relative minimum inlet pressure is given for the pumps installed at 300 m above the sea level. For the pumps installed higher than 300 m above the sea level, the required relative inlet pressure should be increased by 0.1 bar or 0.01 MPa per each 100 m of height. MEGA pumps are allowed to be used only at a height up to 1000 m above the sea level.

Closed valve gate operation

Mega S pumps can work for several days with any rotational frequency when the valve gate is closed without damaging the pump. However, it is recommended to work with the least possible frequency to reduce energy losses. There are no minimum flow requirements.

Note: it is prohibited to close valve gates simultaneously at the inlet and outlet of the pump; during operation one of them should be open to avoid pressure increase.

The temperature of a heat transfer medium and ambient temperature should not exceed the limits of the range indicated.

Pumped liquids

The pump is designed for pure, non-viscous and non-explosive liquids without solids or fibers that can have a mechanical or chemical impact on the pump.

Water used in heating systems should meet the quality requirements of system water for heating.

Mega S pumps can be used to pump glycol and water solutions at the level of up to 50 %.

Ethylene glycol WS example: maximum viscosity = 10–50 cSt ~ solution of water 50 % / glycol 50 % at -10 °C.

Pumping glycol mixtures decreases the maximum curve and performance of the pump that depends on the concentration of water/glycol in the mixture and liquid temperature.

In order to avoid the change in the parameters of glycol solution, you should monitor liquid temperatures that exceed the operation ones and reduce operation time at high temperatures.

Before adding glycol solution in the system, cleaning and purging is required.

In order to avoid corrosion or lime deposits, you should regularly monitor the state of glycol solution. If additional dilution of glycol is required, it is necessary to follow the instructions in the manual sent by the supplier of glycol.

Construction

Electric data

Pump type	Mega S
Enclosure class	IPX4D (EN 60529).
Insulation class	H.
Supply voltage	1 x 230 V+10%, -15%, 50 Hz, PE
Digital input	0–10 V
Analog input	4–20 mA. 0–10 W direct current
Connection bus input	Modbus RTU
Leakage current	$I_{\text{leakage}} < 3.5 \text{ mA}$. Leakage current is measured in accordance with EN 60335-1.
EMC	Standards applied: EN61000-3-2, EN61000-6-3, EN61800-3-3, EN55014-1 and EN55014-2
Cos φ	The pumps connected via terminals are equipped with an integrated active PFC module (power coefficient control) providing the values of cos φ from 0.98 to 0.99, i.e. very close to 1. In configurations with a plug connection there is no PFC, therefore the power coefficient equals from 0.50 to 0.99.

Sound pressure

Sound pressure depends on the power consumed.
Maximum sound pressure — 50/42 dB(A).

Installation

Mechanical installation

Mega S pumps are designed for indoor installation.
Install the pump so that the motor shaft is in a horizontal position.

The pump can be installed both on horizontal and vertical pipelines.

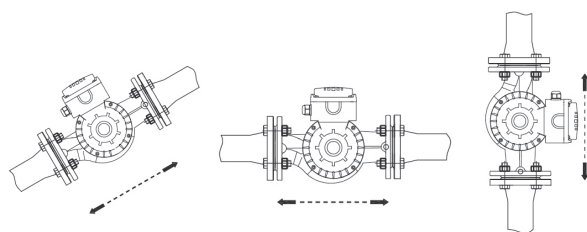

Fig. 53 Installation options

The arrow on the pump housing shows the direction of a liquid flow.

The control unit should be in a horizontal position.

The pump should be installed so that not to be exposed to the weight of the pipeline.

The pump can be installed when suspended directly on the pipeline on condition that the pipeline has an appropriate load bearing capacity.

In order to provide sufficient cooling of the motor and electronic equipment, fulfil the following requirements:

- The pump should be installed so that it can be cooled sufficiently.
- Ambient temperature should not be higher than +40 °C.

Electrical connection

Electric equipment should be connected and protection should be installed according to local regulations and rules. People who have pacemakers should take precautions during installation and maintenance of motors with magnetic components.

- The pump should be connected to an external on/off switch.
- The pump should be appropriately earthed.
- External protection of the pump motor is not required.
- The pump is equipped with thermal protection from slowly growing overloads and blocking.
- When turned on from power supply, the pump starts approx. in 5 seconds.

Note: the pump should not be started and stopped more than 4 times within an hour when supply voltage is turned on and off.

The pump is equipped with a digital input that can be used for external control of start and stop of the pump; turning power on and off is not necessary.

The pump should be connected to power supply in accordance with wirings given in the Certificate, installation and operation manual.

Cables

In order to connect an external switch, digital input, signal transfer from sensors and set values signal transfer, you should use screened cables.

- All the cables should be resistant to temperatures up to +70 °C.
- All the cables should be connected according to EN 60204-1 and EN 50174-2.

Additional protection

While installing the pump, follow local regulation and rules on residual current devices.

Product range

Pump model	Connection size	Port-to-port length, mm	Rated power min/ max, (W)	Rated current min/ max, (A)	Voltage
					230 V
Mega S 40-12F	DN 40	250	35-460	0.28/2.1	•
Mega S 40-15F	DN 40	250	35-680	0.28/3.1	•
Mega S 40-20F	DN 40	250	35-750	0.28/3.4	•
Mega S 50-10F	DN 50	280	35-480	0.28/2.2	•
Mega S 50-12F	DN 50	280	35-600	0.28/2.6	•
Mega S 50-15F	DN 50	280	35-680	0.28/3.0	•
Mega S 50-18F	DN 50	280	35-750	0.28/3.4	•
Mega S 65-8F	DN 65	342	35-570	0.28/2.6	•
Mega S 65-10F	DN 65	342	35-700	0.28/3.1	•
Mega S 65-12F	DN 65	342	35-750	0.28/3.4	•
Mega S 80-6F	DN 80	360	35-580	0.28/2.7	•
Mega S 80-8F	DN 80	360	35-750	0.28/3.4	•

Performance curves and technical data

Mega S 40-12F

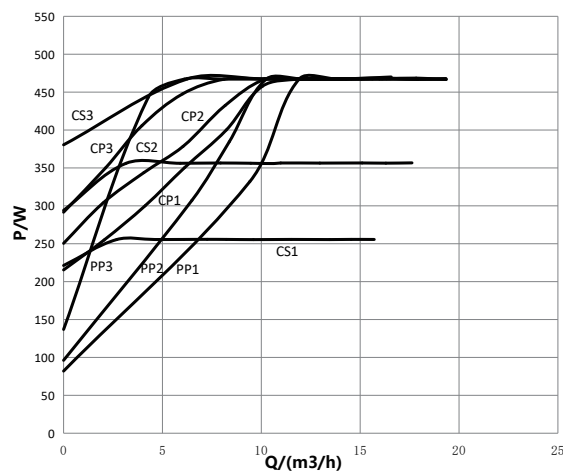
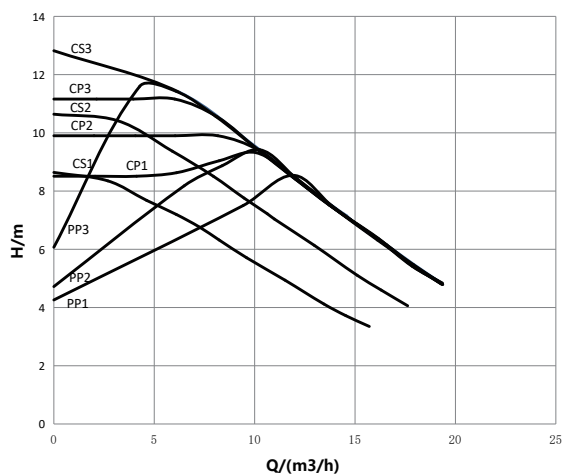

Mega S 40-15F

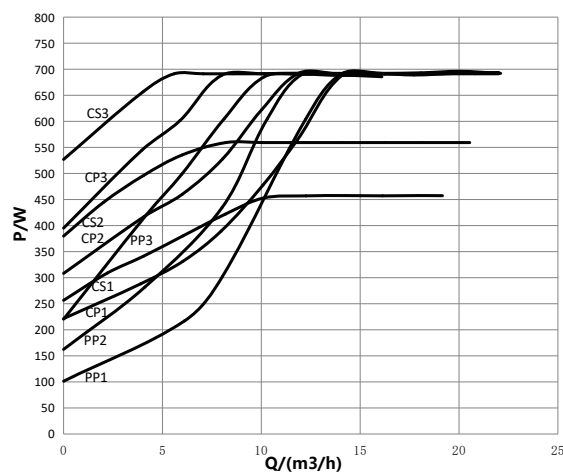
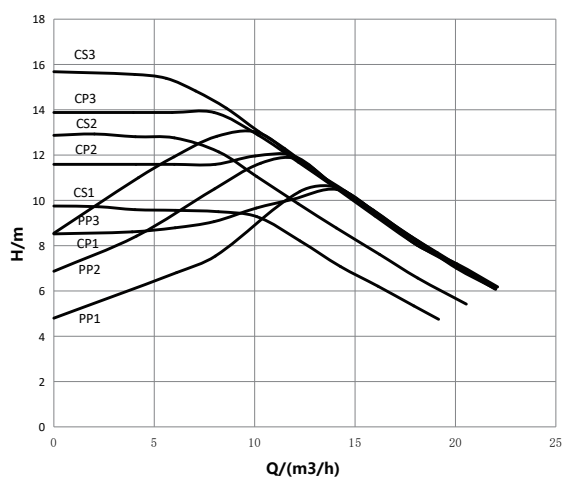

Mega S 40-20F

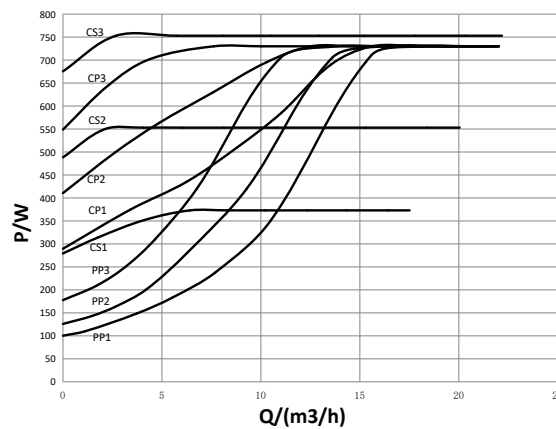
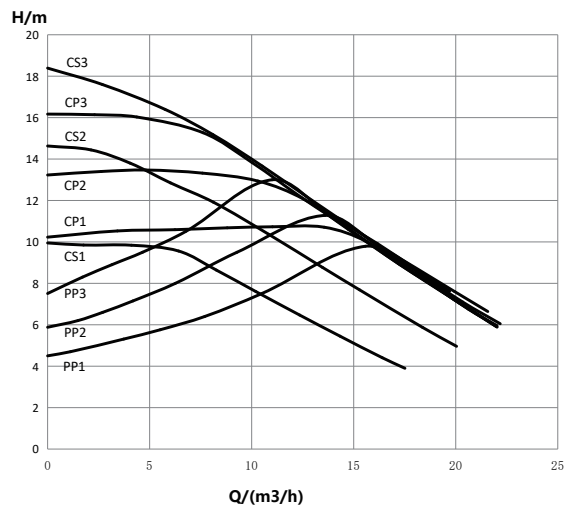

Mega S 50-10F

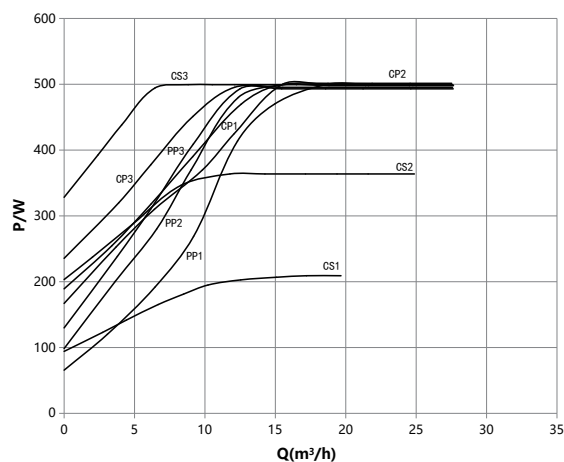
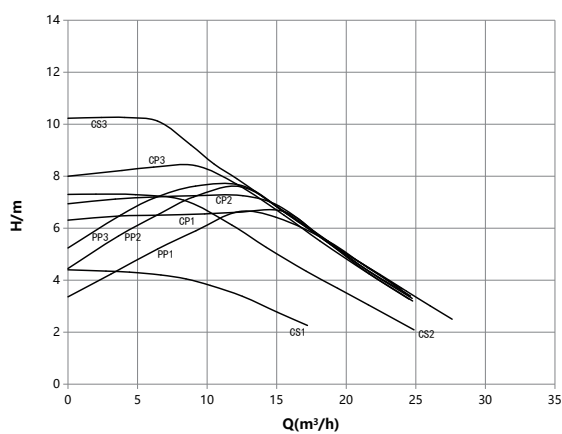

Mega S 50-12F

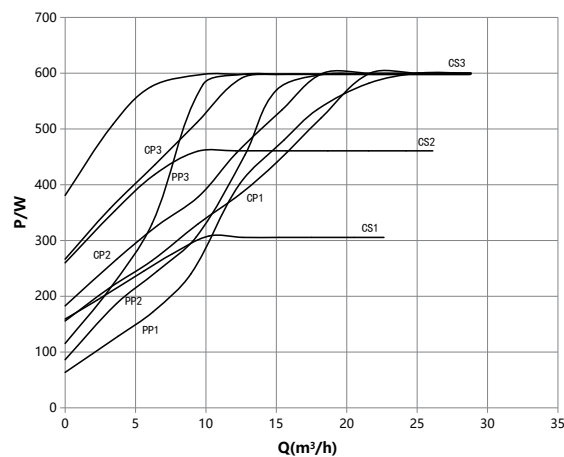
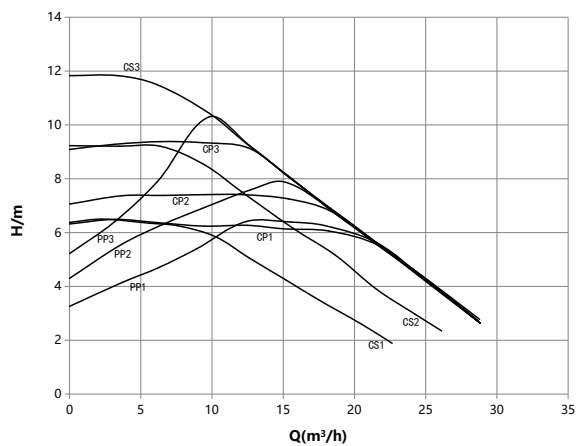

Mega S 50-15F

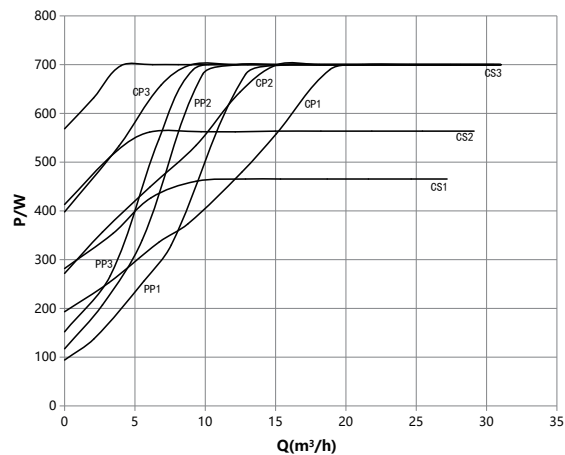
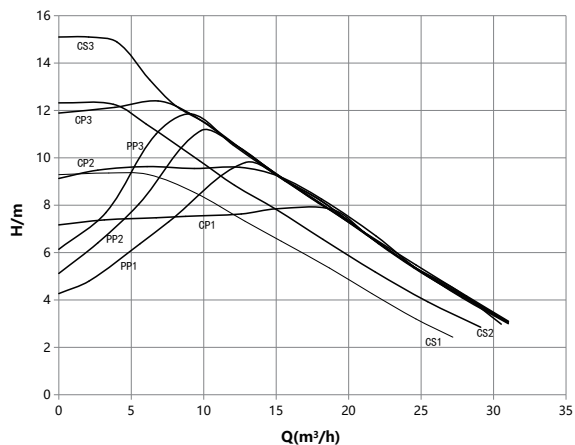

Mega S 50-18F

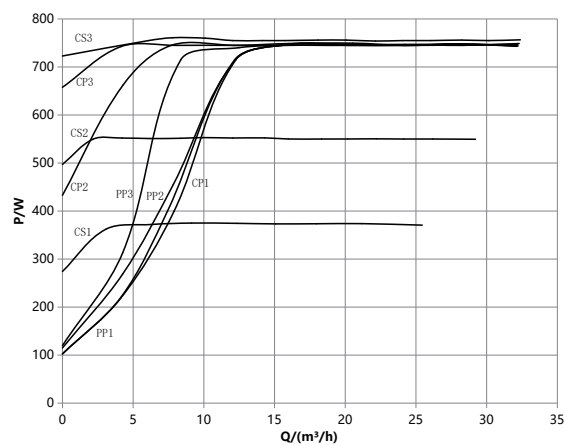
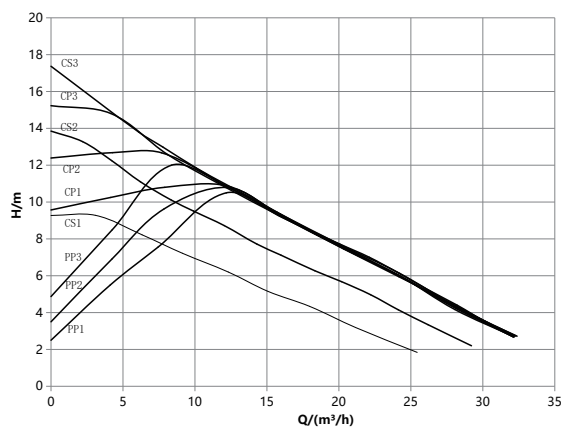

Mega S 65-8F

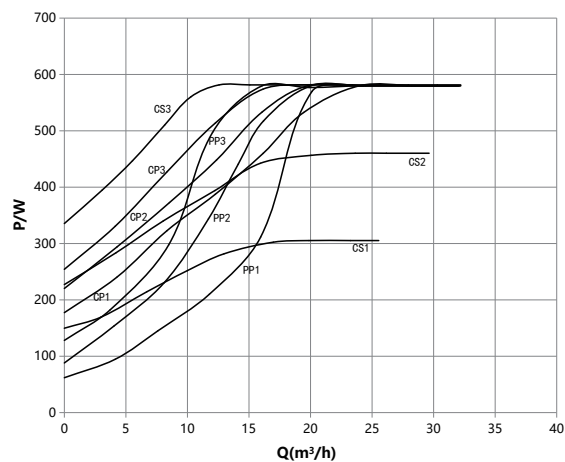
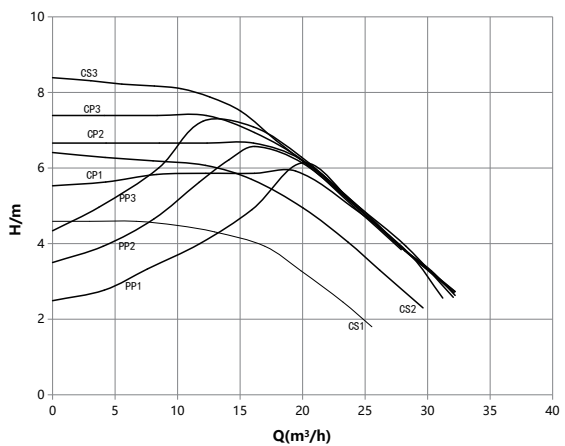

Mega S 65-10F

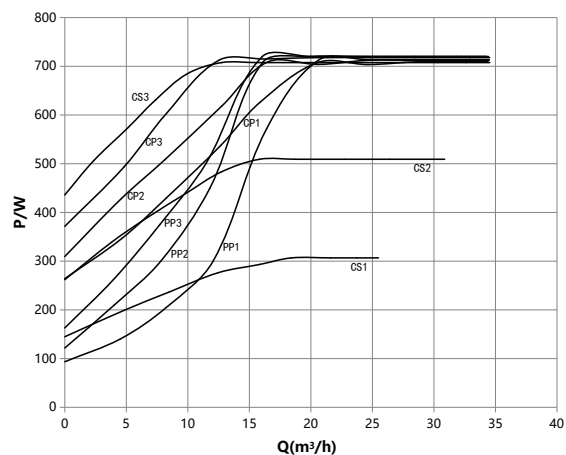
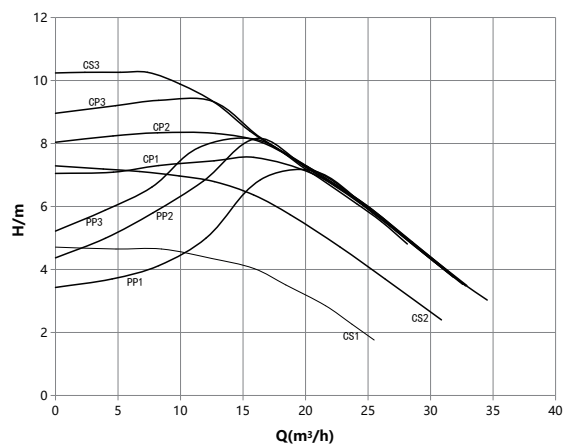

Mega S 65-12F

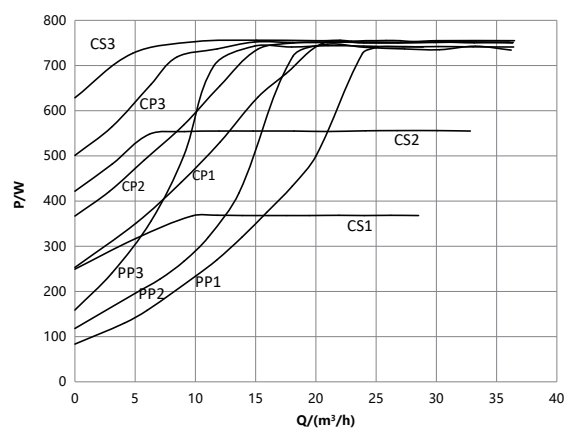
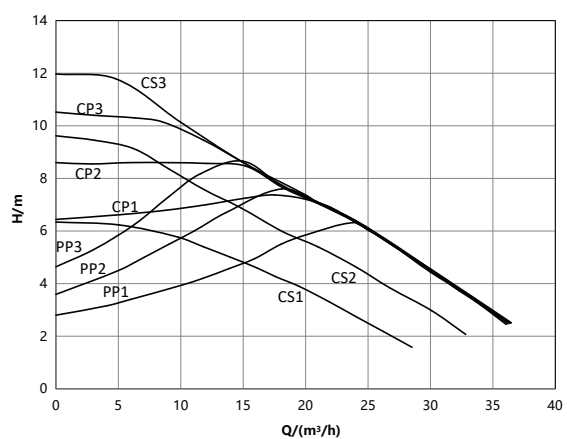

Mega S 80-6F

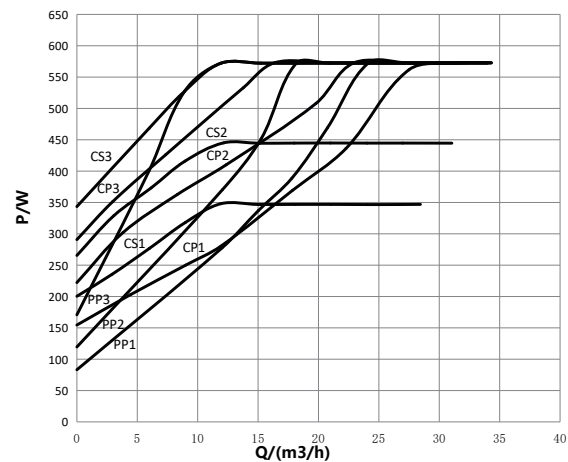
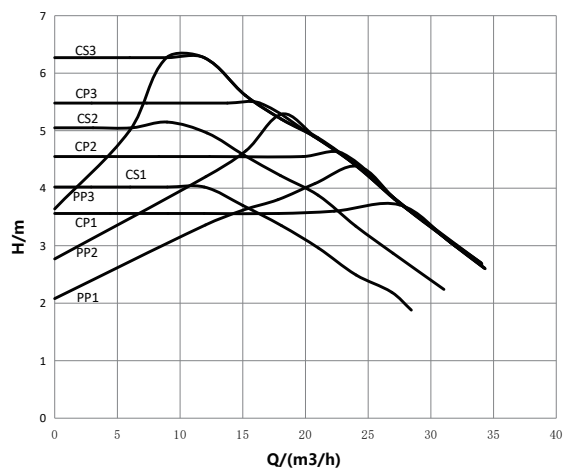

Mega S 80-8F

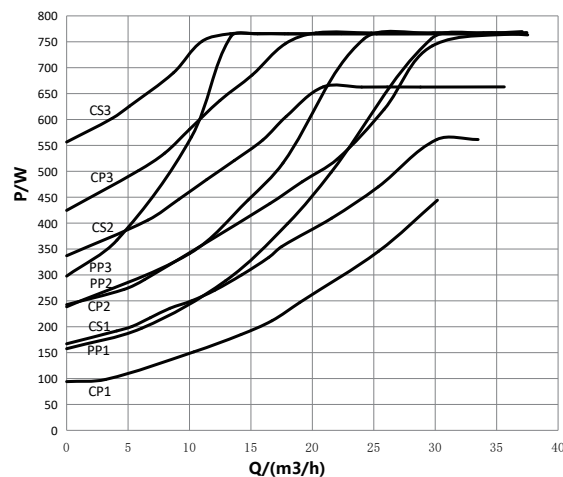
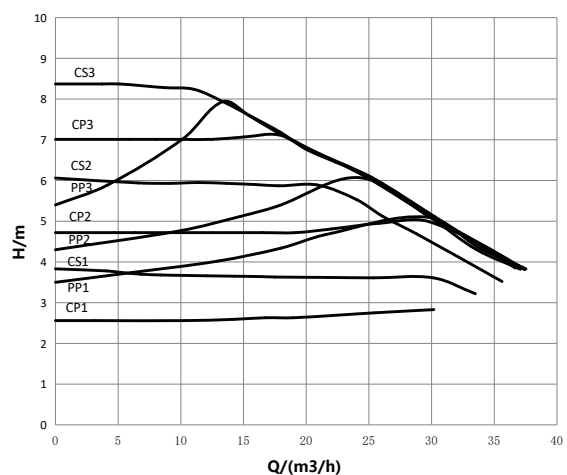

Dimensions

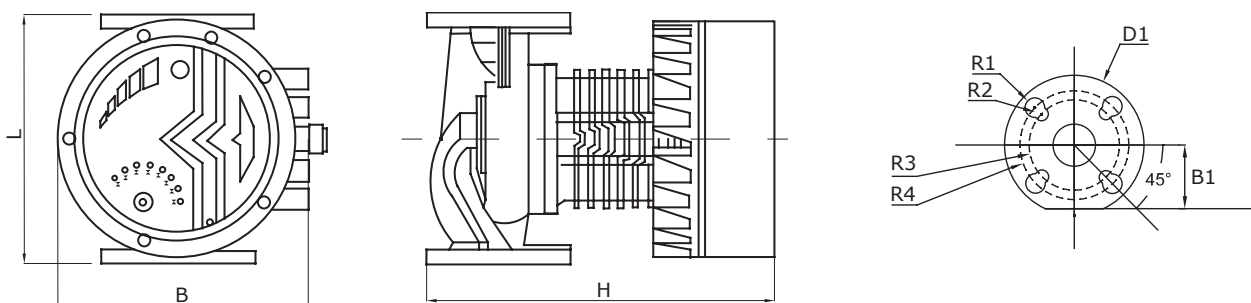

	Pump dimensions [mm]			Flange dimensions [mm]						
	L	B	H	B1	D1	D2	R1	R2	R3	R4
Mega S 40-12F	250	266	377	65	150	40	9.5	7	50	55
Mega S 40-15F	250	266	377	65	150	40	9.5	7	50	55
Mega S 40-20F	250	266	377	65	150	40	9.5	7	50	55
Mega S 50-10F	280	266	380	73.1	165	50	9.5	7	55	62.5
Mega S 50-12F	280	266	380	73.1	165	50	9.5	7	55	62.5
Mega S 50-15F	280	266	380	73.1	165	50	9.5	7	55	62.5
Mega S 50-18F	280	266	380	73.1	165	50	9.5	7	55	62.5
Mega S 65-8F	342	266	380	73.5	185	68	9.5	7	65	72.5
Mega S 65-10F	342	266	380	73.5	185	68	9.5	7	65	72.5
Mega S 65-12F	342	266	380	73.5	185	68	9.5	7	65	72.5
Mega S 80-6F	360	266	390	92	200	80	9.5	9.5	75	80
Mega S 80-8F	360	266	390	92	200	80	9.5	9.5	75	80

Instant circulator pump



Instant 15-1.5 pump



Instant E 15-1.5

Type key

Instant

Example	Instant	15	-1.5
Type range	[Line connecting Instant, 15, and -1.5]		
Nominal diameter of inlet and outlet ports (DN) [mm] 15 = Rp1/2", installation length of the pump – 80 mm	[Line connecting 15 and -1.5]		
Rated head [m]	[Line connecting Instant and -1.5]		

Application

Instant circulator pumps are designed for hot water circulation in water supply systems of private houses and flats.

The pumps can be used for open and closed systems. Constructed for indoor installation.

A water-conducting part of these pumps is made of corrosion-resistant brass to protect them from chemical contact with hot pumped water. The pumps are energy-efficient and silent due to their advanced Functional drawing of multi-circuit hot water recirculation. Reduced installation lengths and compact size of these pumps allow integrating them into the recirculation circuit even in the tightest space. If applicable, dismountable design will allow easily purging the flow part of the pump.

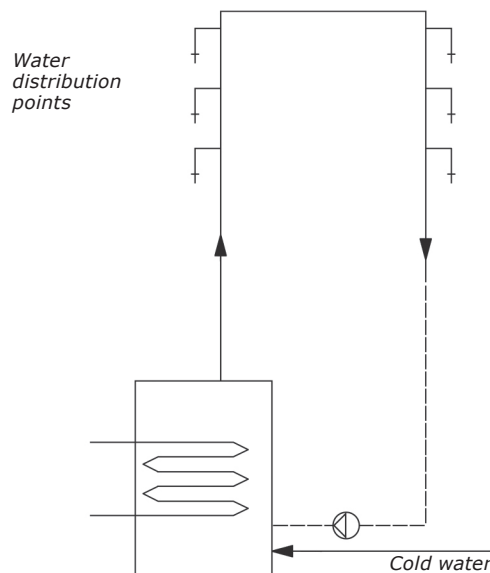

Fig. 11 Functional drawing of one-circuit hot water recirculation

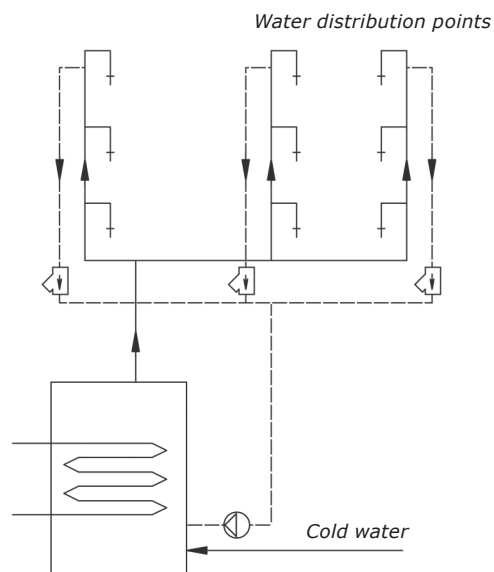

Fig. 12 Functional drawing of multi-circuit hot water recirculation

Operating conditions

Pumped liquids

- Pure, non-viscous, non-aggressive, and non-explosive liquids without solids or fibers.
- Cooling liquids without mineral oils.
- Domestic hot water with hardness max. 14 °dH, max. 110 °C.
- Softened water.

Kinematic water viscosity $\nu = 1 \text{ mm}^2/\text{s}$ (1 cSt) at 20 °C. When a circulator pump is used to pump a more viscous liquid, performance of the hydraulic system decreases.

Liquid temperature

From +2 to +110 °C. It is recommended to maintain a temperature from 50 to 60 °C to minimize lime deposits and prevent Legionella.

Ambient and liquid temperatures

A temperature of pumped liquid should always be higher than ambient temperature. Otherwise, there can appear condensation in the housing.

Maximum system pressure

Pumps with units (PN 10): 1.0 MPa (10 bar).

Inlet pressure

To avoid cavitation noise and pump bearings damage, the following minimal pressure should be set up for an inlet port:

Liquid temperature	75 °C	90 °C	110 °C
Inlet pressure	0.5 m	5 m	10.8 m
	0.05bar	0.5 bar	1.08 bar

Construction

Instant pumps design allows disconnecting the motor of the pump from the housing for easier maintenance. A rotor bearing is lubricated with pumped liquid. The pumps feature:

- parts contacting with pumped liquid are isolated from stator placed in a sealed stainless steel case;
- friction decrease in a bearing and absence of slop provide significant decrease in consumed power and noise.

Instant pumps are equipped with single-phase permanent-magnet motors.

The motor has full electric resistance and heat protection.

The motor does not require any additional protection.

Enclosure class: IP 44.

Insulation thermal resistance class: H.

Dry-running protection

Instant pumps have dry-running protection. Its operation uses the shift of a spheric rotor if operated without water. If the pump elbow is filled with liquid, water presses the rotor and fixes it in the space. If the pump run is dry, the pump elbow is filled with air in which the rotor loses its fixed position. As a result, the magnetic field created by the rotor is also shifted in the space and changes its magnetization degree in the measured point. The pump motor recognizes it and stops. As soon as the rotor returns to its initial position, the motor starts again and stops again if there is still no water. If there is no water in the system, the pump will work in frequent start-stop cycles until there is water in the system or the pump is manually disconnected from power supply.

This mode will not lead to the pump motor overheating due to its low power and the absence of load. This periodic work allows reducing friction and wear of the rotor bearing, therefore, the pump is protected from critical damages when operated without water.

Material specification

No.	Name	Material
1	Stator surface	Composite
2	Stator winding	Copper wire with lacquer coating
3	Stator housing	Aluminum
4	shielding sleeve	Stainless steel
5	Rotor sleeve	Stainless steel
6	Rotor	Stainless steel
7	Pump housing	Brass
8	Terminal box cover	PC/ABS
9	Motor cover	PPO
10	Cable with plug	Composite
11	Impeller	Composite

Installation

Instant circulator pumps should be securely fastened at the operation place so that there can be no risk of tipping over, falling or a sudden movement.

The pump should always be installed with the motor shaft in a horizontal position.

Upper position of the electrical connector in an Instant pump is unacceptable.

In order to remove air from the system with an Instant pump you should:

1. Turn on the pump, open the valve.
2. Turn off the pump, close the valve.
3. Repeat steps 1, 2 five times.

Performance curve and technical data

Instant 15-1.5

1 x 230 V, 50 Hz

Port-to-port length: 80 mm

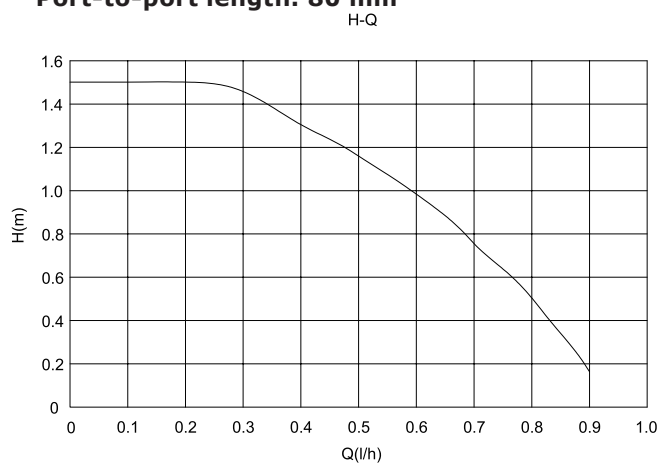

P₁ [W]	I_{1/1} [A]
5	0.08

System pressure: Max. 10 bar
Liquid temperature: from +2 to +110 °C (TF 110)

Instant E 15-1.5

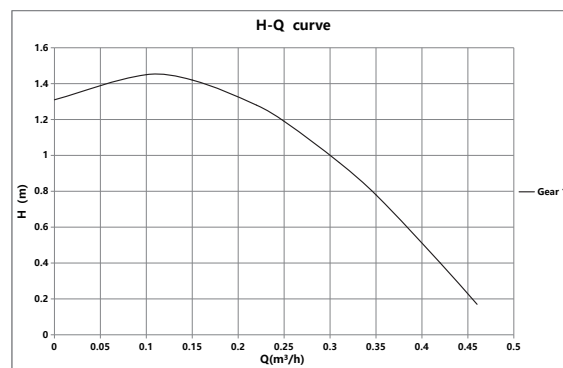

P₁ [W]	I_{1/1} [A]
28	0.28

System pressure: Max. 10 bar
Liquid temperature: from +2 to +110 °C (TF 110)

Dimensions

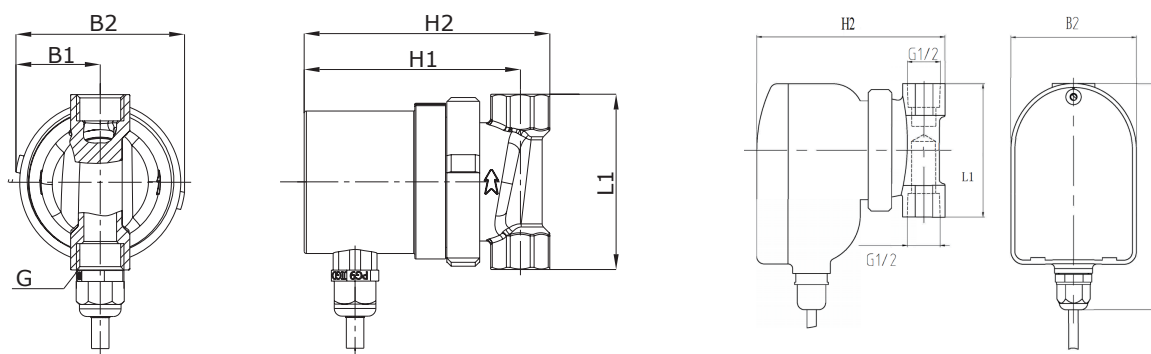

Pump type	Size [mm]					
	L1	H1	H2	B1	B2	RP [inch]
Instant 15-1.5	80	99	112	38	77	1/2
Instant E 15-1.5	85	/	120	40	80	1/2

Instant S circulator pump



Fig.1 Instant S circulator pump

Type key

Instant S

Example

The circulation pump is made of copper pump body, and the simplified version of the second-generation micro circulation series energy-saving pipeline shielded electric pump product.

Superior

In and outlet diameter(mm)

Maximal pump head(m)

Instant S -

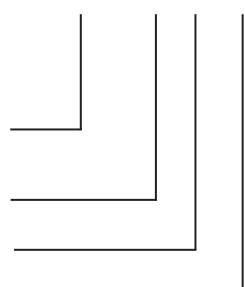

Application

Instant S circulator pumps are designed for hot water circulation in water supply systems of private houses and flats. The pumps can be used for open and closed systems. Constructional for indoor installation. A water-conducting part of these pumps is made of corrosion-resistant brass to protect them from chemical contact with hot pumped water. The pumps are energy-efficient and silent due to their advanced Functional drawing of multi-circuit hot water recirculation. Reduced installation lengths and compact size of these pumps allow integrating them into the recirculation circuit even in the tightest space. If applicable, dismantlable design will allow easily purging the flow part of the pump

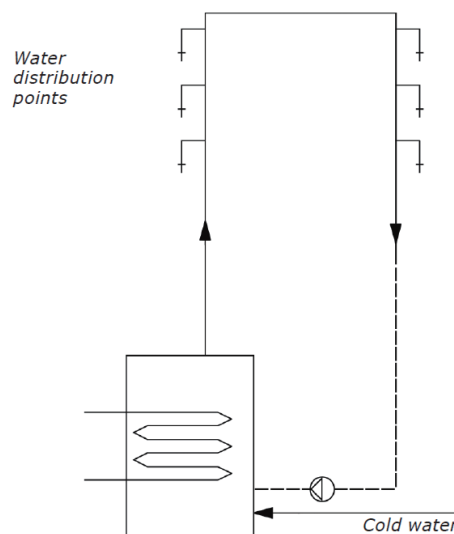

Fig.2 Functional drawing of one-circuit hot water recirculation

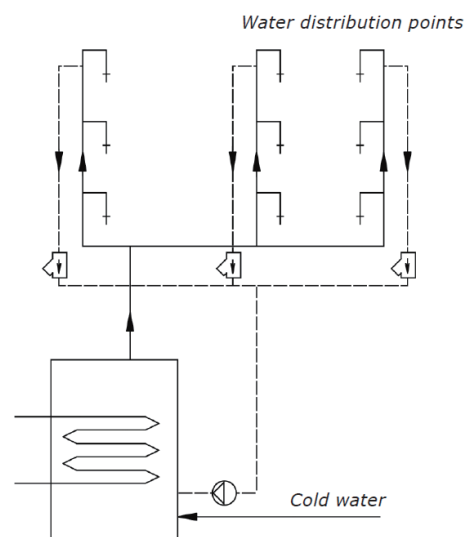

Fig.3 Functional drawing of multi-circuit hot water recirculation

Operating conditions

Pumped liquids

- Pure, non-viscous, non-aggressive, and non-explosive liquids without solids or fibers.
- Cooling liquids without mineral oils.
- Domestic hot water with hardness max. 14 °dH, max. 95 °C.

- Softened water.

Kinematic water viscosity $\nu = 1 \text{ mm}^2/\text{s}$ (1 cSt) at 20 °C. When a circulator pump is used to pump a more viscous liquid, performance of the hydraulic system decreases.

Liquid temperature

From +2 to +95 °C. It is recommended to maintain a temperature from 50 to 60 °C to minimize lime deposits and prevent Legionella

Ambient and liquid temperatures

A temperature of pumped liquid should always be higher than ambient temperature. Otherwise, there can appear condensation in the housing.

Maximum system pressure

Pumps with units (PN 10): 1.0 MPa (10 bar).

Inlet pressure

To avoid cavitation noise and pump bearings damage, the following minimal pressure should be set up for an inlet port:

Name	<85°C	95°C
Lidinlet pressure	0.5 m	2.8 m
	0.05bar	0.28bar

Construction

Instant S pumps design allows disconnecting the motor of the pump from the housing for easier maintenance. A rotor bearing is lubricated with pumped liquid. The pumps feature:

- parts contacting with pumped liquid are isolated from stator placed in a sealed stainless steel case;
- friction decrease in a bearing and absence of slop provide significant decrease in consumed power and noise.

Instant S pumps are equipped with single-phase permanent-magnet motors.

The motor has full electric resistance. The motor does not require any additional protection.

Enclosure class: IP 44.

Insulation thermal resistance class: H.

Dry-running protection

Instant S circulator pumps have dry-running protection. Its operation uses the shift of a spheric rotor if operated without water. If the pump elbow is filled with liquid, water presses the rotor and fixes it in the space. If the pump run is dry, the pump elbow is filled with air in which the rotor loses its fixed position. As a result, the magnetic field created by the rotor is also shifted in the space and changes its magnetization degree in the measured point. The pump motor recognizes it and stops. As soon as the rotor returns to its initial position, the motor starts again and stops again if there is still no water. If there is no water in the system, the pump will work in frequent start-stop cycles until there is water in the system or the pump is manually disconnected from power supply.

This mode will not lead to the pump motor overheating due to its low power and the absence of load. This periodic work allows reducing friction and wear of the rotor bearing, therefore, the pump is protected from critical damages when operated without water

Material specification

No.	Name	Material
1	Lid	Aluminum alloy+engineering plastics
2	Terminal box assembly	Engineering plastic
3	Pump housing	HPb57-3
4	Impeller	Composite material
5	Rotor assembly	Assembly

Performance curve and technical data Instant S
230 V, 50/60 Hz

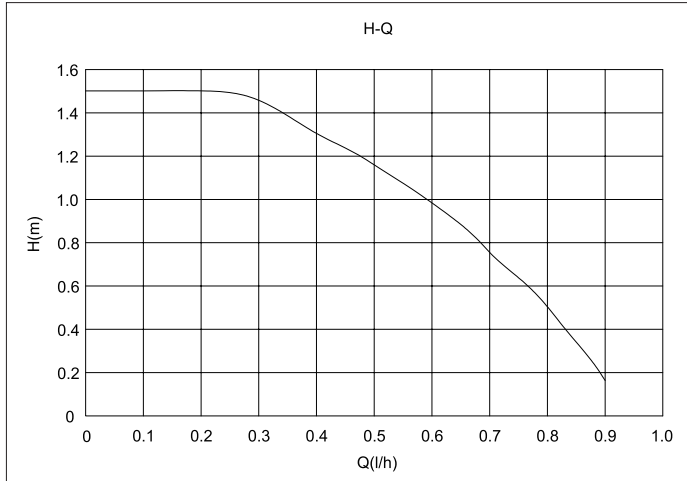
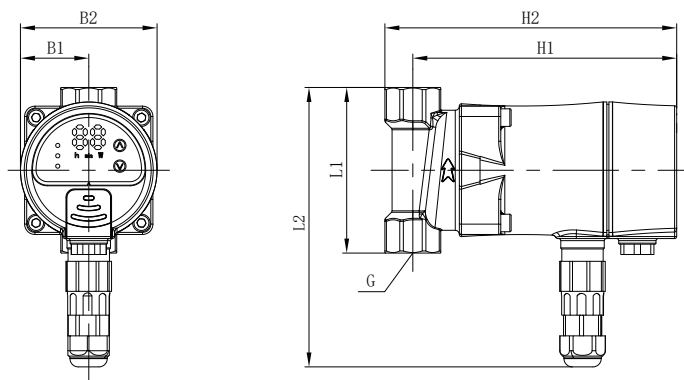

Fig.4 Performance curve

P1 [W]	I1/1 [A]
8W	0.07A

Technical data System pressure: Max. 10 bar **Liquid temperature:** from +2 to +95 °C (TF 95)

Dimensions



Pump type	Size [mm]						RP [inch]
	L1	L2	H1	H2	B1	B2	
Instant S	80	135	127.5	141	33	66	1/2

Instant hot water circulator pump



Fig. 1 Instant hot water pump

Application

Instant hot water circulator pump is mainly used for water circulation or pressurization in domestic hot water systems. The front of the product has an operation panel for easy operation.

Application Scenarios

Usage Scenario 1 (There is no water return pipe in waterways, no power supply at the farthest water point, and the pump has circulation and pressurization functions)

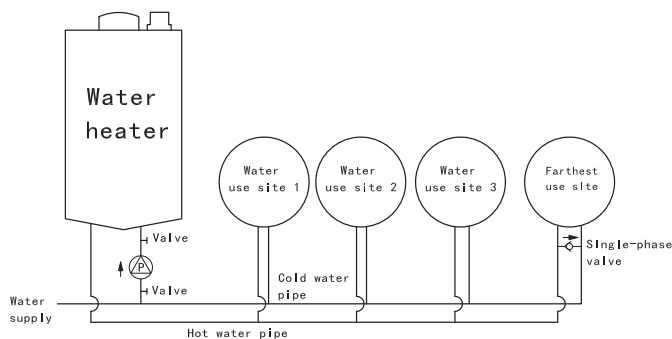

Fig.2 Usage Scenario 1

Note: Valves should be installed on both sides of the pump for convenient maintenance

Usage Scenario 2 (There is no water return pipe in waterways, the farthest water point has power supply. The pump has circulation function)

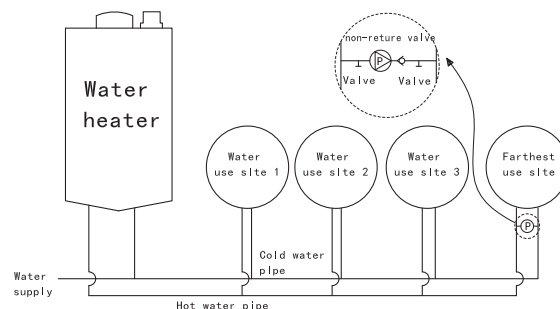

Fig.3 Usage Scenario 2

Note: Valves should be installed on both sides of the pump for convenient maintenance

Usage Scenario 3 (Water channel with return water pipe, pump with circulation and pressurization function)

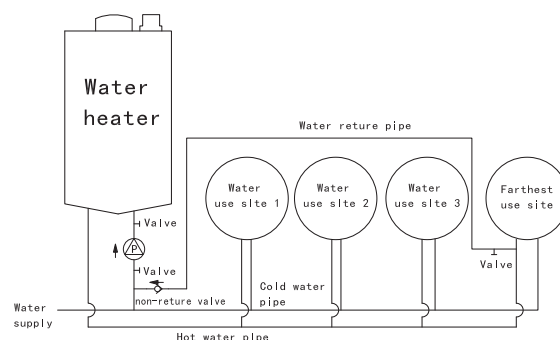

Fig.4 Usage Scenario 3

Usage Scenario 4 (Water channels have return pipes and the pump has the function of circulation.)

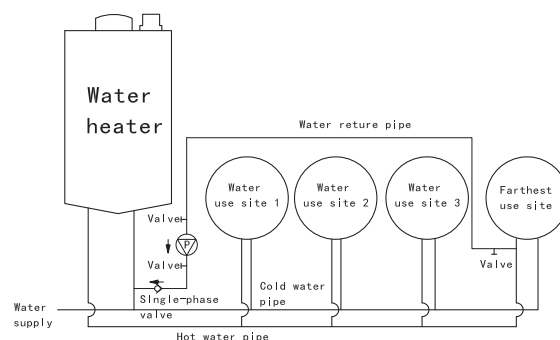

Fig.5 Usage Scenario 4

Note: Valves should be installed on both sides of the pump for convenient maintenance

Operating conditions

Conditions of use(keep the shaft horizontal)

Medium: clear water	Medium temperature: 4℃~80℃
Ambient temperature: 0℃~+40℃。	0.1bar(Liquid temperature≤+60℃) 0.28 bar(Liquid temperature≤+80℃)
Medium hardness: 25°dH	Relative humidity of the air: 95%(MAX)

Conditions of storage

Humidity of storage environment 30%~95%	Storage ambient temperature: -20℃~60℃ (there is no freezing in the pipeline and water pump)
Stacking height: less than 6 layers	

Electric control instructions

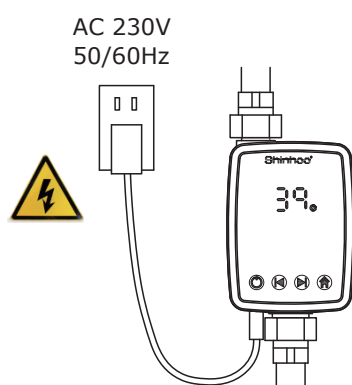

Fig.6 Wiring Diagram

Check that the supply voltage and frequency are consistent with the parameters indicated on the pump nameplate.

Use the adapter that comes with the pump to connect to the power supply.

The light on the control panel indicates that the power is on.

Display interface and Function Description during pump operation

● **one-click start function:** After the user touches the "Start" button, the pump starts to run. When the water temperature reaches the set temperature upper limit or there is no flow in the pipeline, the pump stops running. After starting, click the "Start" button again to shut down the pump.

● **Timing function:** The current time is within the set period, if the water temperature is lower than the lower limit, the pump starts to run. When the water temperature reaches the upper limit or there is no flow in the pipe, the pump stops running.

● **All-day mode function:** If the water temperature is lower than the set lower limit, the pump starts to run. When the water temperature reaches the set upper limit or there is no flow in the pipeline, the pump stops running.

● **Faucet start function:** Lift the faucet for about 1 second, the pump starts to run, and stops running when the water temperature reaches the set temperature upper limit or there is no flow in the pipeline.

● **Pressurization function:** When there is fluid flow in the pump, the pump starts and is in pressurization mode; When the liquid does not flow, the pump stops. This mode does not have temperature control.

Pump parameter setting

● **"One-click start" parameter setting:** After the screen is lit up, hold down the "HOME" button for 2 seconds, then the corresponding mode on the screen starts to blink, tap the "HOME" button, select the "one-button start" mode to blink, tap the "Forward" button to select the parameter to be set, the corresponding parameter blinks after selection, tap the "Back" button parameter value increases in cycles. After the parameters are set as required, Hold down the "HOME" button" for 2 seconds to exit the parameter setting screen, or tap the HOME button to enter the next mode setting.

● **"Timing mode" parameter setting:** After the screen is lit up, hold down the "HOME" button for 2 seconds, then the corresponding mode on the screen starts to blink. Tap the "HOME" button and select the "Timing mode" mode to blink. Tap the "Forward" button to select the parameter to be set, the corresponding parameter blinks after selection, tap the "Back" button parameter value increases in cycles. Tap the "Start" button to select Early, Middle, or Late. After the parameters are set as required, hold down the HOME button for 2 seconds to exit the parameter setting screen, or tap the HOME button to enter the next setting mode.

● **"All-day mode" parameter setting:** After the screen is lit up, hold down the "HOME" button for 2 seconds, then the corresponding mode on the screen starts to blink. Tap the "HOME" button and select "All-Day Mode" to blink. Tap the "Forward" button to select the parameter that you want to set, the corresponding parameter blinks after selection, tap the "Back" button parameter value increases in cycles. After the parameters are set as required, hold down the HOME button for 2 seconds to exit the parameter setting screen, or tap the HOME button to enter the next mode setting.

● **Time calibration (time alignment):** After the screen is lit up, hold down the "HOME" button for 2 seconds, then the corresponding mode on the screen starts to blink. Tap the "HOME" button and select "Time Settings" to blink. Tap "Forward" to select a parameter to be set, the corresponding parameter blinks after selection, tap the "Back" button parameter value increases in cycles. After the timing is complete, hold down the "HOME" button for 2 seconds to exit the parameter setting screen, or tap the "HOME" button to enter the next mode setting.

Pump operation and fault self-check

After the power is turned on, the corresponding mode light will be on in the mode area, and the water temperature and running indicator will be on in the operation display area.

The failure of the electric pump to work normally is displayed as follows on the display interface:

Fault type	Fault code	Protection mode
Over-voltage protection	E0	Test under full load conditions: Detects the input voltage above $29V \pm 5\%$, after 2 seconds the pump enters overvoltage protection. The pump will work normally if the voltage returns to the normal state.
Under-voltage protection	E1	Test under full load conditions: the detection input voltage is lower than $19V \pm 5\%$, after 2S it enters the under-voltage protection. After The pump will work normally if the voltage returns to the normal state.
Over-current protection	E2	The water pump will stop working immediately if the current is too high. And it will be restarted after 8s. The water pump will be completely protected and will not be restarted unless the power is re-energized if the protection accumulates to 5 times.
Light load protection	E3	The pump is not loaded or the load is low, or the flow sensor is not working properly.
Phase loss protection	E4	Power on to detect phase loss, the water pump will stop working immediately when the phase-loss fault is detected. The water pump will be restarted after 8s. The water pump will be completely protected and will not be restarted unless the power is re-energized if the protection accumulates to 5 times.
Stalled rotor protection	E5	The water pump will stop working after the rotor locked 3 second, Pump will stop working, and restart after 8s. The water pump will be completely protected and will not be restarted unless the power is re-energized if the protection accumulates to 5 times.
The temperature parameter is invalid	F0	The lower limit of temperature is greater than the upper limit of temperature.
Timing parameter setting is invalid (early)	F1	The start time of the timing is longer than the end time.
Timing Parameter Settings are invalid (Medium)	F2	The start time of the timing is longer than the end time.
Timing Parameter Settings are invalid (late)	F3	The start time of the timing is longer than the end time.
Battery low voltage	F4	Check the battery voltage when the battery is powered on. If the battery voltage is low, a fault message is displayed 3 seconds after the battery is powered on, indicating that the battery needs to be replaced. (Battery failure will affect the system time in timing mode.)
Temperature sensor anomaly	FF	The temperature sensor is not connected properly or is abnormal.

If a fault is displayed, the power supply must be disconnected for troubleshooting.

After troubleshooting, reconnect the power supply and start the pump.

Startup and mode selection

Before starting the electric pump, ensure that the system is filled with liquid and the power supply is in good contact.

Set item	Setting instructions
One-click start	After touching the "Start" button, the pump will start to run. When the water temperature reaches the set temperature upper limit or there is no flow in the pipeline or the set temperature upper limit cannot be reached after continuous running for 3 minutes, the pump will stop running. Suitable for use without long periods of hot water or outside the range of other modes.
Timing mode	When the water temperature in the pump is lower than the set temperature lower limit, the pump starts to operate, and when the water temperature in the pump reaches the set temperature upper limit or there is no flow in the pipeline, the pump stops running. This mode is suitable for water use time stabilization.
All-day mode	The pump runs 24 hours. Suitable for all day long pressurization or cycling.
Faucet start	Lift the faucet for about 1 second, the pump starts to run, turn off the tap, and stops running when the water temperature reaches the set temperature upper limit or there is no flow in the pipeline. Suitable for bathing and other occasions.
Pressurization mode	Set the temperature range to 00-00, pump in pressurized mode, when there is fluid flow in the pump, the pump starts; When the liquid does not flow, the pump stops. Suitable for home water level is low, do not need temperature control function occasions.
Time set up	Set the time before the product is used, so that the pump time is consistent with the current time, and avoid the timing mode inconsistent with the expected setting time.
Temperature setting	The minimum temperature should be set higher than the current water temperature and the current ambient temperature to avoid the pump can not start after the pipeline water temperature is reduced; The set maximum temperature should be less than the current heat source temperature 2-3 ° C, to avoid the long-term circulation pipe temperature can not reach the set temperature, the pump can not stop. Avoid the pump inlet temperature is less than the current heat source temperature, resulting in frequent pump start.
Time setting	A maximum of 3 time periods can be set, which is 24h system. When 3 time periods are not required, the unnecessary time can be set as 0000-0000

Construction

Instant hot water pump is of the canned-rotor type. In these pumps, the rotor of the motor is washed by pumped liquid.

Water in such pumps is used to:

- 1.Lubricate the bearings of an motor and remove wear debris.
- 2.Cooling of the stator winding.

Construction advantages of Instant hot water pump:

- An energy-efficient brand new permanent- magnet motor and increased starting torque.
- A ceramic shaft and bearings with the same temperature extension coefficient provide increased reliability of the equipment.
- A thrust bearing is made of ceramic that extends the service life of the pump.
- A rotor can and thrust bearing are made of stainless steel to resist corrosion.
- Simplified pump connection to power supply with a plug.

Material specification

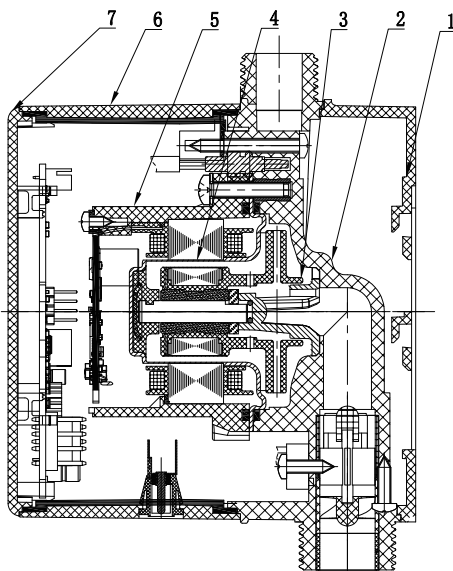

Fig. 7 Sectional drawing

No.	Name	Material
1	Base	Composite material
2	Pump housing	Composite material
3	Assembled rotor	Assembly
4	Shielding sleeve assembly	Stainless steel
5	Box base	Composite material
6	Terminal box base	Composite material
7	Terminal box cover	ABS

Performance curve and technical data

Performance curve

Maximum flow	> 20 L/min
Maximum head	12 m
Maximum Power	60W
Rated flow:	10 L/min
Rated head	8m

HEAD

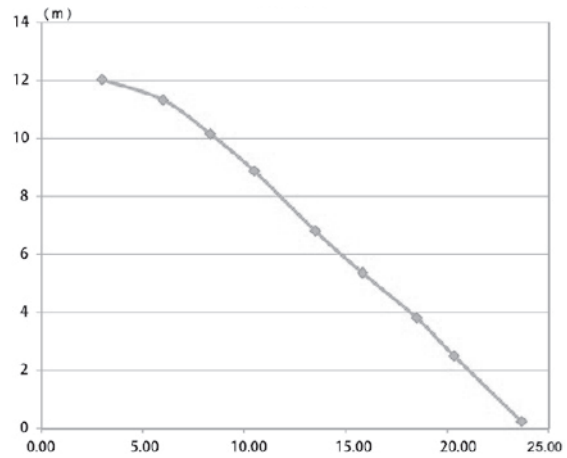

POWER

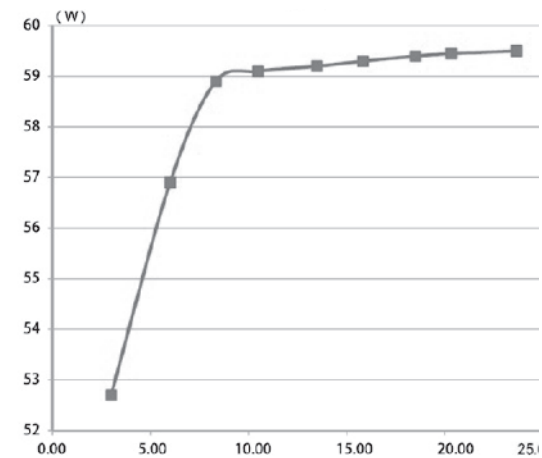

Technical data

Power voltage	230V, 50/60Hz	
Protection level	IP44	
Insulation level	H	
Ambient relative air humidity (RH)	≤95%	
System pressure level	10bar	
Inlet pressure	Liquid temperature	Inlet pressure (Min)
	≤+60℃	0.1 bar
	≤+80℃	0.28 bar
Noise level	<42dB (A)	
Ambient temperature	0~+40℃	
Temperature rating	TF80	
Surface temperature	≤+80℃	
Liquid temperature	4℃~+80℃	

Dimensions

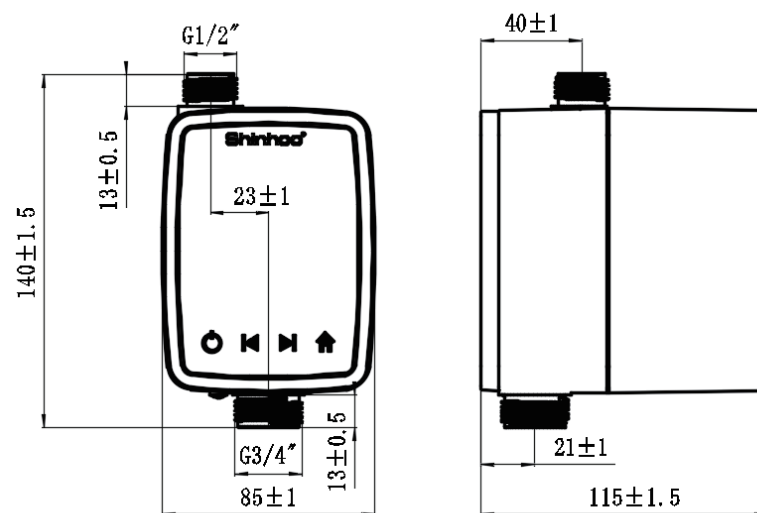

Fig.8 Installation dimension

Aquamaster booster pump



Fig.1 Aquamaster pump

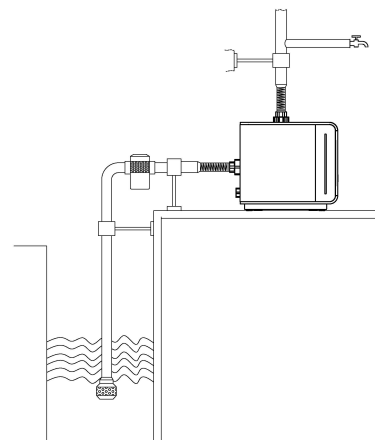

Fig. 4 Suction from well or tank

Application

- 1. Commercial water pressurization
- 2. Drawing water from groundwater for domestic use
- 3. Domestic water supply pressurization

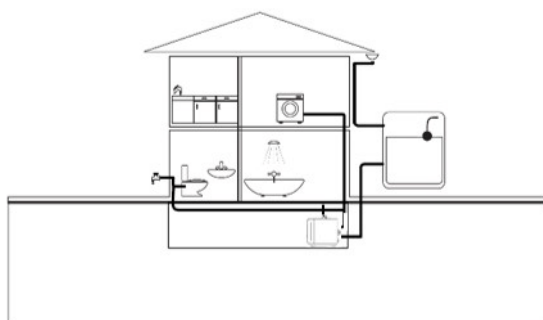

Fig.2 Tower water supply

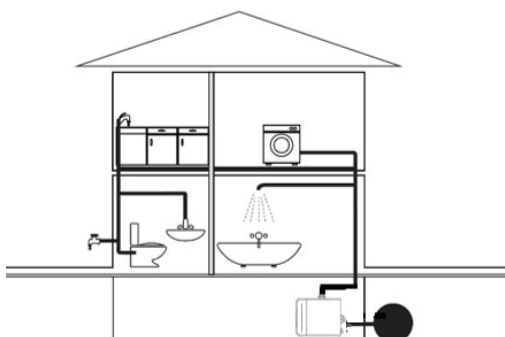

Fig.3 Pressurization of urban tap water

Operating conditions

Pos.	Description
1	Highset tapping point
2	Flexible hoses
3	Pipe hangers and supports
4	Inlet filter (If the water may contain sand, gravel or other debris please install a filter on the inlet side to protect the pump and installation)
5	Foot valve with strainer
6	Maximum suctionlift is 8 m
7	Inlet pipe must be submersed at least 0.5 m

Technical data

NO.	Component Name	Material Name
1	Guide Vane	Engineering Plastic
2	Pump Body	Engineering Plastic
3	Plug	Engineering Plastic
4	Middle Shell	Engineering Plastic
5	Pipe Fitting	304 Stainless Steel
6	Check Valve	Assembly
7	Pipe Nut	Engineering Plastic
8	Pressure Tank	Assembly
9	Front Cover	Engineering Plastic
10	Top Cover	Engineering Plastic
11	Outer Box Base	Engineering Plastic

Technical data

NO.	Component Name	Material Name
12	Outer Box Lid	Engineering Plastic
13	Drive Board	Assembly
14	Display Board	Assembly
15	Base Frame	Cast Aluminum
16	Inner Box Lid	Engineering Plastic
17	Rear End Cap	Cast Aluminum
19	Rotor	Assembly
18	Power Cord	Assembly
21	Stator Winding	Assembly
20	Water Cooled Shell	304 Stainless Steel
22	Bearing	Assembly
23	Mechanical Seal	Assembly
24	Impeller	Assembly
25	Base	Engineering Plastic
26	Temperature Sensor	Assembly
27	Pressure Sensor	Assembly

Pumped liquids

Pumped liquids: fresh water	Temperature range: 0 to+50 °C
PH:6.5-8.5	Hardness :25°dH
Solid impurity content in the medium: the diameter and length of solid impurities ≤ 0.1mm, and the volume ratio is ≤0.1%.	

Environment requirements

Installation: Keep the shaft Horizontal	Altitude: <1000m
Environment temperature range: 0 to+55 °C (There is no freezing phenomenon in the pipeline and water pump)	Use environment humidity:<95%

Storage requirements

Temperature range during storing: -20 to +60 °C(There is no freezing phenomenon in the pipeline and water pump)	Maximum relative humidity during storing:95%RH
--	--

Function description

1. Constant pressure control function

Under the corresponding gear, when the outlet flow is within a certain range, the outlet head can reach the corresponding value stably

Material specification

Temperature protection function:

1. Display real-time temperature.
2. High temperature mode: When the temperature is higher than 60 °C(±10%) for two consecutive times during operation, the pump stops, and when the water temperature is lower than 55 °C (±10%), the pump automatically restarts.
3. Anti-freeze mode: When the temperature is lower than 5°C for two consecutive times in standby mode, the pump restarts immediately. After continuous operation for 40 minutes, the pump waits for continuous detection.

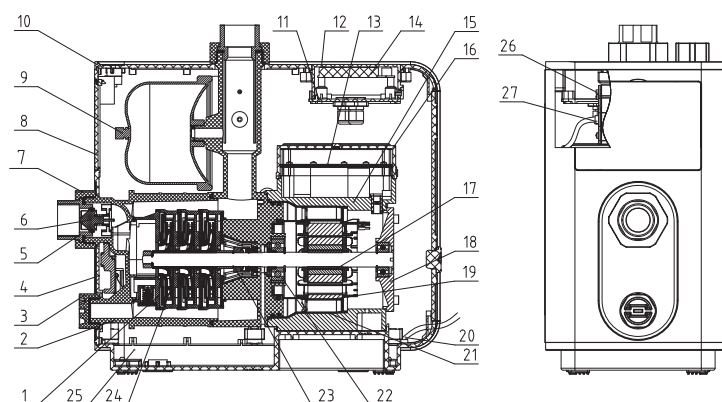

Electric control instructions

This pump has a built-in control program, the user only need to according to their own water needs, against the performance curve (Fig.6), through the operating panel to select the appropriate pressure gear can be

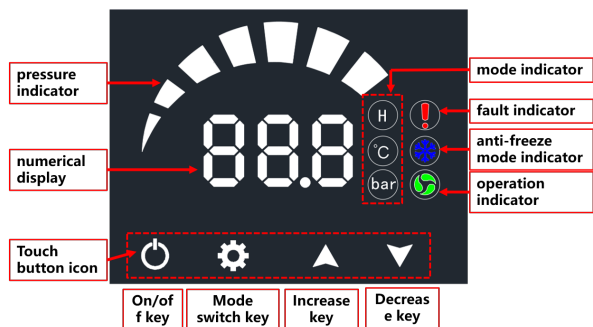

Fig.5 Operation interface

Construction

Pumps feature

- Variable frequency constant pressure water supply.
- Multi-stage pressure boosting impeller.
- Water-cooled motor.

Performance curves and technical data

Performance curves

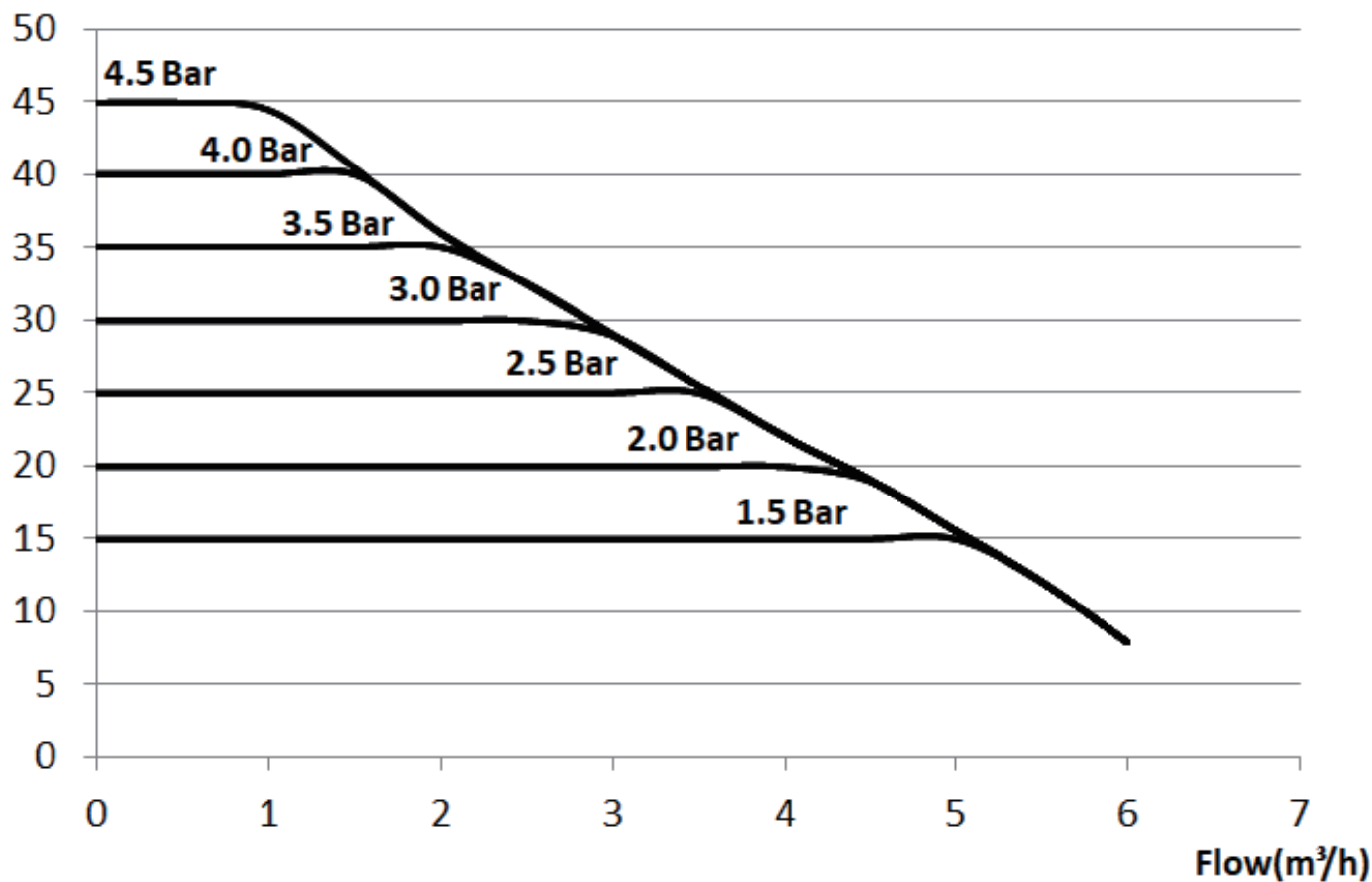

Fig.6 Performance curves

Technical data

Rated voltage: 230V	Rated current: 2.9A	Frequency: 50Hz
Max. flow: 5.5m³/h	Max. head: 45m	Max. input power: 600W
Norminal flow : 3m³/h	Norminal head: 30m	IP rating: IP44
Direction: Counterclockwise when viewed from pump inlet	Insulation class: F	Max. Suction head: 8m

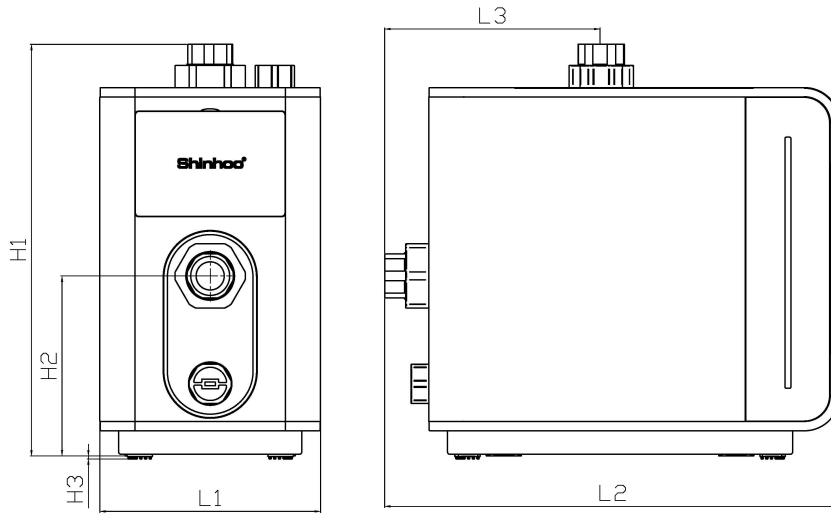

Fig.7 External dimensions

Dimensions

Pump model	Size (mm)						
	L1	L2	L3	H1	H2	H3	G (inch)
Aquamaster	188	390	185	351	153.5	2.5	G1(internal thread)

Basic S circulator pumps



Fig. 3 Basic S pump

Type key

BASIC S

Example	Basic S	25	-4	S	180
Type range	_____				
Nominal diameter of inlet and outlet ports (DN), [mm]	_____				
Maximum head, [m]	_____				
Three-speed motor	_____				
Port-to-port length, [mm]	_____				

Application

Basic S pumps are used in different heating systems (one- or two-pipe heating systems, underfloor heating systems, mixing loops of large heating systems).

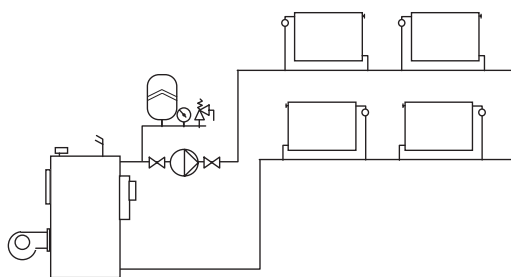

Fig. 4 One-pipe heating system

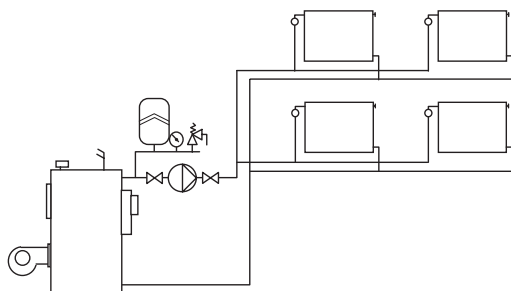

Fig. 5 Two-pipe heating system

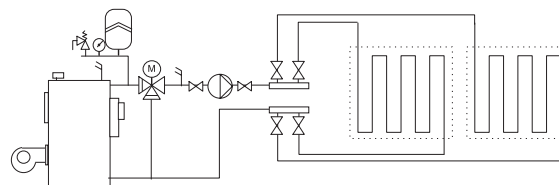

Fig. 6 Underfloor heating system

Operating conditions

Pumped liquids

Basic S circulator pumps are available in different configurations and work with the following liquid types:

- pure, non-viscous, non-corrosive, and non-explosive liquids without solids or fibers;
- cooling liquids without mineral oils;
- softened water.

Kinematic water viscosity $\nu = 1 \text{ mm}^2/\text{s}$ (1 cSt) at $20 \text{ }^\circ\text{C}$. When a circulator pump is used to pump more viscous liquid, performance of the hydraulic system decreases. Exclude additives that can negatively effect pump operation.

The pump should be selected according to pumped liquid viscosity.

Liquid temperature

Allowable temperature of pumped liquid: from $+2$ to $+110 \text{ }^\circ\text{C}$.

Ambient temperature

Allowable ambient temperature: from 0 to $+40 \text{ }^\circ\text{C}$. Temperature of pumped liquid should always be higher than ambient temperature. Otherwise, during operation there can be condensation water in stator and condensation water will bring pump out of operation.

Storage temperature

Storage temperature: from -30 to $+55 \text{ }^\circ\text{C}$.

Maximum system pressure

Pumps with unions (PN 10): 1.0 MPa (10 bar).

Inlet pressure

To avoid cavitation noise and pump bearings damage, the following minimal pressure should be set up for an inlet port:

Liquid temperature	$\leq 85 \text{ }^\circ\text{C}$	$110 \text{ }^\circ\text{C}$
Inlet pressure	6 m	7.5 m
	0.6 bar	0.75 bar

Sound pressure

Maximum sound pressure: 45 dB(A) .

Construction

Basic S pumps are of the canned-rotor type, i.e. the pump and motor form a single unit without shaft seal that uses only two sealing gaskets. Bearings are lubricated with pumped liquid (see Fig. 7).

These pumps feature:

- ceramic radial bearings;
- carbon thrust bearing;
- stainless steel protective rotor can and bearing plate;
- impeller made of corrosion-resistant material;
- cast iron pump housing with cataphoretic coating.

Pumps are supplied with a three-speed motor. Two- or four-pole asynchronous squirrel-cage motor.

A terminal box can be easily opened and is equipped with clips for cable connection. A cable inlet has a sealing and device to reduce mechanic stress in the cable.

The cable inlet can be protruded outside from the guide bush for easier installation.

Easy access to the terminal box with a cable tension compensator.

The motor complies with the Low Voltage Directive (LVD).

There are different configurations with different positions of terminal boxes to provide correct cable connection.

Insulation class: H.

Cable connection: Pg 11 for cables from 5.6 to 10 mm.

The motor does not require additional external protection and is equipped with built-in overtemperature protection depending on the pump model.

Material specification

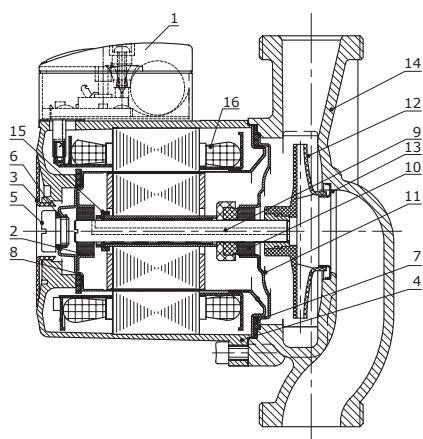

Fig. 7 Sectional drawing

No.	Name	Material
1	Terminal box	Composite PPE/PS
	Terminal box cover	Composite PPE/PS
	Electric unit	Composite PET
2	Radial bearing	Ceramics
3	Nameplate	Composite
4	Stator housing	Aluminum
	Stator winding cap	Composite PET
5	Air valve screw	Nickel-plated brass
6.7	Gaskets	Rubber EPDM
8	Rotor can	Stainless steel
9	External rotor can	Stainless steel
10	Thrust bearing	Carbon
	Thrust bearing retainer	Rubber EPDM
11	Bearing plate	Stainless steel
12	Impeller	Composite PES/PP
13	Neck ring	Stainless steel
14	Pump housing	Cast iron with cataphoretic coating
15	Stop ring	Composite PES
16	Intermediate ring	Stainless steel

Installation

Basic S circulator pumps should be securely fastened at the operation place so that there can be no risk of tipping over, falling or a sudden movement.

The pump should always be installed with the motor shaft in a horizontal position.

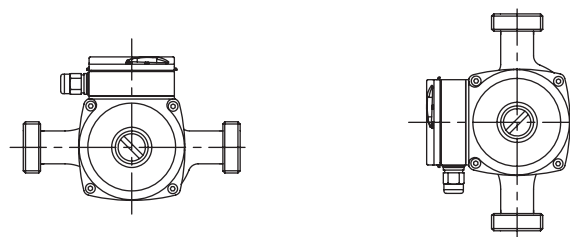

Fig. 8 Possible shaft position

The following position of the terminal box is possible:

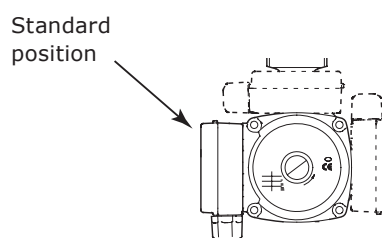

Fig. 9 The following position of the control box of the heating system

Product range

Basic S three-speed pumps

Housing material: cast iron with cathoretic coating.

Pump model	Connection size	Port-to-port length, mm	Rated flow, (m ³ /h)	Rated head, (m)	Rated power, (W)	Rated current, (A)	Voltage
							230V
Basic S 20-4S	1"-3/4"	130	1.6	2.2	50/40/30	0.23/0.2/0.16	•
Basic S 25-4S	1 1/2"-1"	130/180	1.6	2.2			•
Basic S 32-4S	2"-1 1/4"	180	1.8	2.2			•
Basic S 20-5S	1"-3/4"	130	1.8	2.8	65/50/40	0.26/0.23/0.20	•
Basic S 25-5S	1 1/2"-1"	130/180	1.8	2.8			•
Basic S 32-5S	2"-1 1/4"	180	1.8	2.5			•
Basic S 20-6S	1"-3/4"	130	1.8	3.2	70/60/50	0.3/0.26/0.23	•
Basic S 25-6S	1 1/2"-1"	130/180	2	3			•
Basic S 32-6S	2"-1 1/4"	180	2	3			•
Basic S 20-7S	1"-3/4"	130	2	4.3	140/115/70	0.73/0.52/0.33	•
Basic S 25-7S	1 1/2"-1"	130/180	2.5	4			•
Basic S 32-7S	2"-1 1/4"	180	2.5	4.9			•
Basic S 25-8S	1 1/2"-1"	180	3.2	6	180/175/130	0.8/0.78/0.58	•
Basic S 32-8S	2"-1 1/4"	180	4	5			•

Performance curves and technical data

Basic 20-4S-130

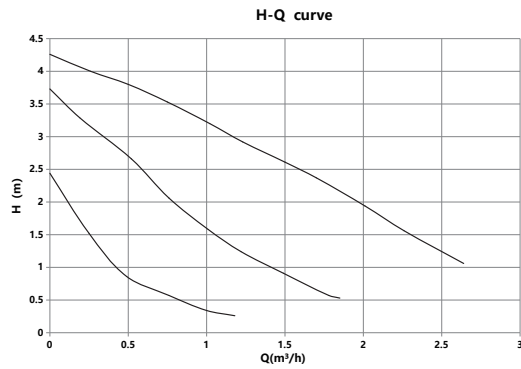

Basic 25-4S-130

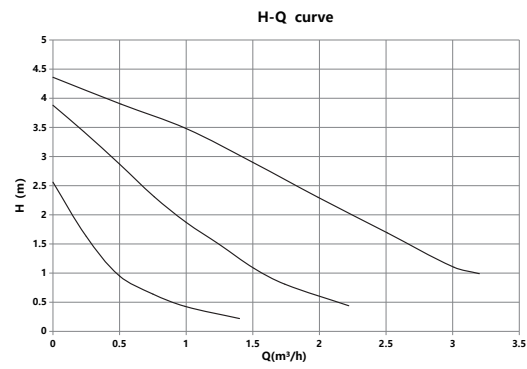

Basic 32-4S-180

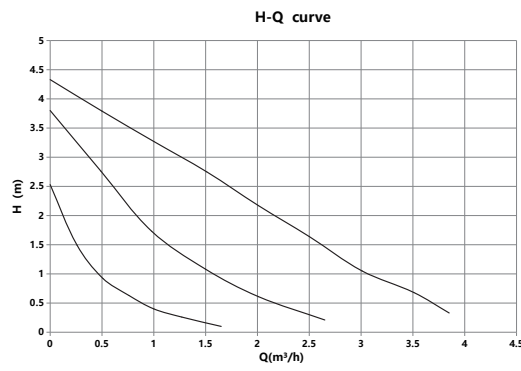

Basic 20-5S-130

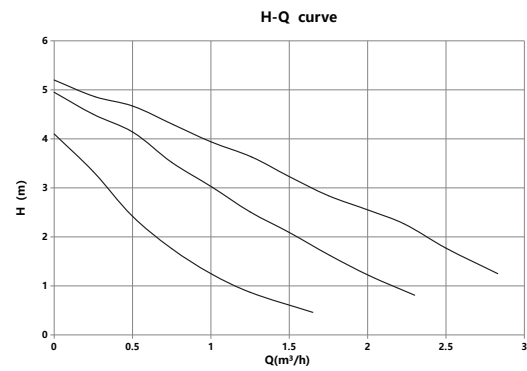

Basic 25-5S-130

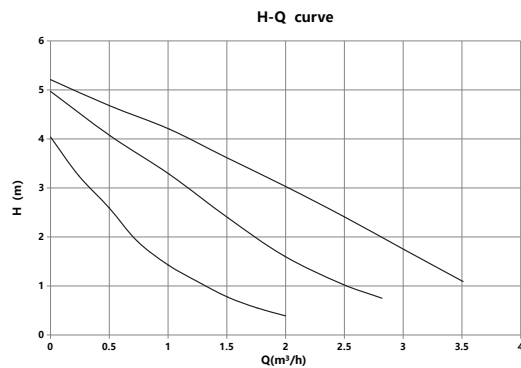

Basic 32-5S-180

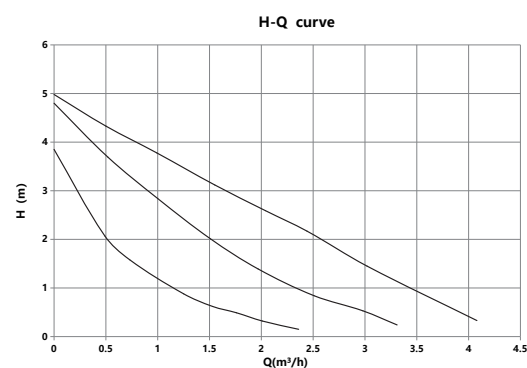

Basic 20-6S-130

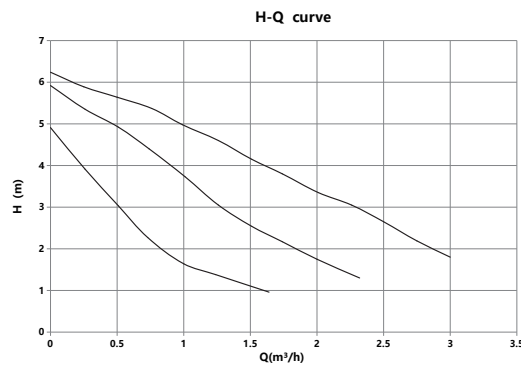

Basic 25-6S-130

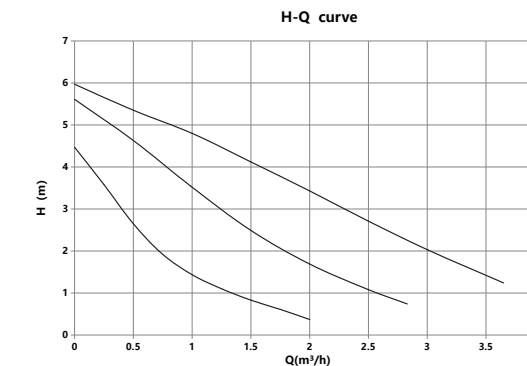

Performance curves and technical data

Basic 32-6S-180

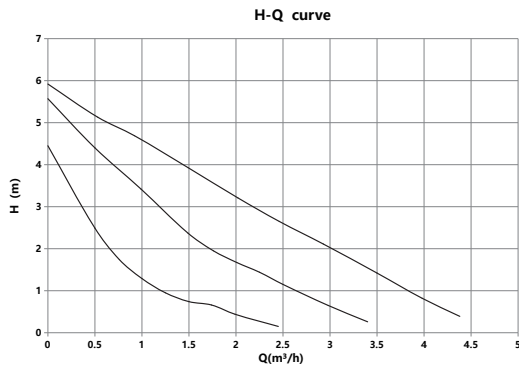

Basic 20-7S-130

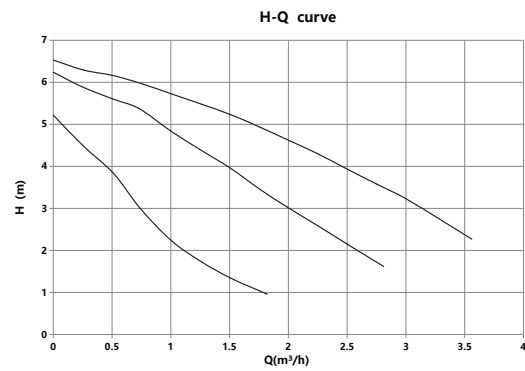

Basic 25-7S-130

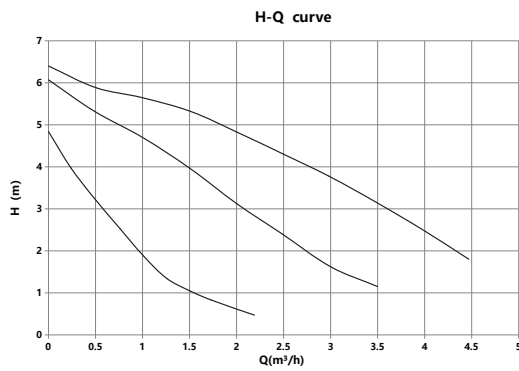

Basic 32-7S-180

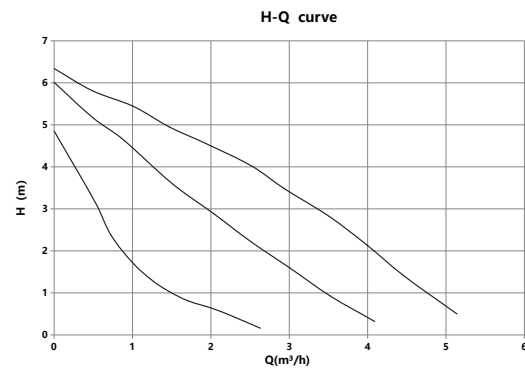

Basic 25-8S-180

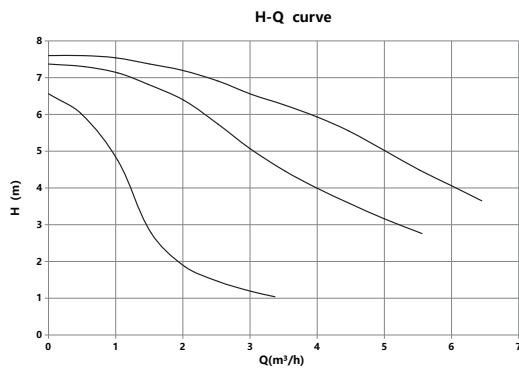

Basic 32-8S-180

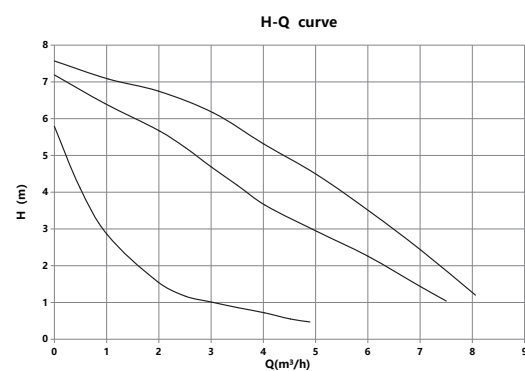

Dimensions

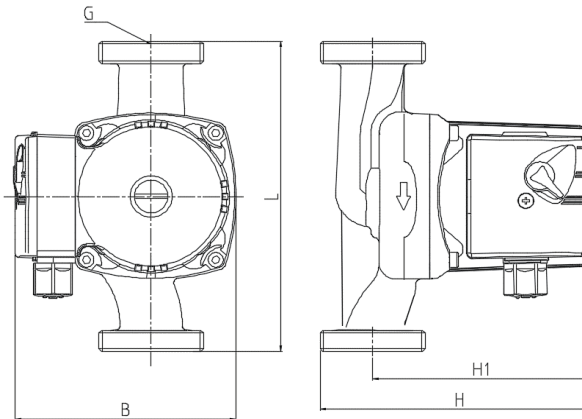

Pump model	L	B	H	H1	G[inch]
Basic S 20-4S	130	130	130	105	1"
Basic S 25-4S	130/180	130	130	105	1 1/2"
Basic S 32-4S	180	130	130	105	2"
Basic S 20-5S	130	130	130	105	1"
Basic S 25-5S	130/180	130	130	105	1 1/2"
Basic S 32-5S	180	130	130	105	2"
Basic S 20-6S	130	130	130	105	1"
Basic S 25-6S	130/180	130	130	105	1 1/2"
Basic S 32-6S	180	130	130	105	2"
Basic S 20-7S	130	130	130	105	1"
Basic S 25-7S	130/180	130	130	105	1 1/2"
Basic S 32-7S	180	130	130	105	2"
Basic S 25-8S	180	150	170	130	1 1/2"
Basic S 32-8S	180	150	170	130	2"

Basic circulator pumps



Fig. 13 Basic pump

Type key

Example	Basic	65	-12	S	F
Type range	_____				
Rated flange diameter [mm]	_____				
Maximum head [m]	_____				
Three-speed motor (if no marks, then single speed)	_____				
Flange configuration (if no marks, then threaded)	_____				

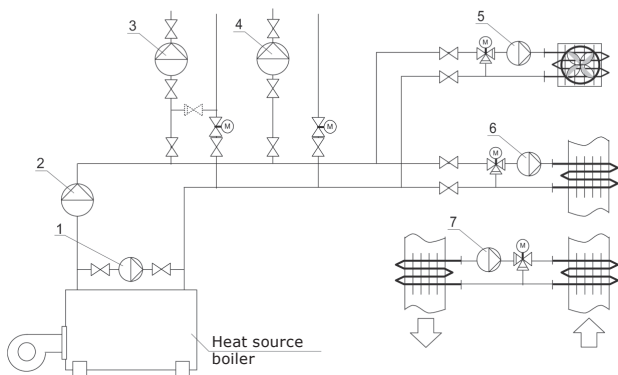

Fig. 14 Functional drawing of heating and heat supply system

1. Boiler circuit pump
2. Primary circuit pump
3. Pump in one- and two-pipe heating systems
4. Heating circuit pump in a hot water supply system
5. Heat pump in air heating systems
6. Pump for underfloor heating systems
7. Heat regeneration and recovery systems

Application

BASIC circulator pumps for cold and hot water circulation in heating and air conditioning systems. The pump involves three rotational frequencies that allow selecting the best performance for a certain hydraulic system.

System pressure: max. 10 bar.

Liquid temperature: from +2 to +110 °C.

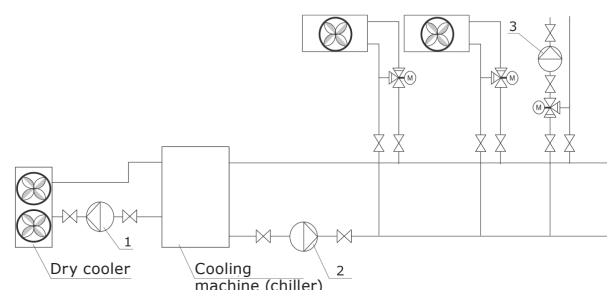

Fig. 15 Functional drawing of cooling and air conditioning system

Operating conditions

Pumped liquids

The pump is designed to pump pure and non corrosive liquids without solids or fibers that can have a mechanical or chemical impact on the pump. Water used in heating systems should meet the quality requirements of system water for heating units.

The pumps must not be used for inflammable or explosive liquids such as diesel fuel or petrol. The pumps must not be used for corrosive liquids such as acids or sea water.

If the pump is operated during a cold season, take the necessary measures to avoid low temperature damages.

Using additives in a heat transfer medium with the density and/or kinetic viscosity higher than the water ones decreases the performance of the pump. Never use the additives that can negatively affect the pump operation.

In order to learn whether the pump can be used with a certain liquid, take into account several factors. The most important are lime content, pH, temperature, and the content of solvents and oils. The pump can be used for glycol and water mixtures at the level up to 50%. Pumping of glycol mixtures decreases hydraulic performance of the pump.

Allowable temperature limits

The pump involves three rotational frequencies that allow selecting the best performance for a certain hydraulic system.

Ambient temperature	from 0 to 40 °C
Liquid temperature	from +2 to +110 °C
Storage temperature	from -30 to +55 °C

1. Condenser and dry cooler circuit pump
2. Consumer circuit pump (fan coils)
3. Pump of cold supply systems in central air conditioners

Depending on the pump application, local rules can limit maximum allowable temperature of pumped liquid.

Relative air humidity	max. 95 %
System pressure	PN10
Test liquid	+20 °C water containing corrosion inhibitor

Inlet pressure

In order to avoid cavitation, it is required to maintain minimum inlet pressure. Minimum pressure allowable is given in the table below:

Model range	Liquid temperature		
	70 °C (bar)	90 °C (bar)	110 °C (bar)
Basic15-9S	85 C/0.6	0.75	1.5
Basic15-12S	85 C/0.6	0.75	1.5
Basic20-12S	85 C/0.6	0.75	1.5
Basic25-12S	85 C/0.6	0.75	1.5
Basic25-9S	0.35	0.75	1.2
Basic32-9S	0.35	0.75	1.2
Basic25-12SL	0.35	0.75	1.2
Basic25-12S(500W)	0.4	0.75	1.4
Basic32-12S	0.4	0.75	1.4
Basic25-16	0.8	1.1	1.7
Basic25-20	0.7	0.95	1.6
Basic32-8SF	85 C/0.6	0.75	1.5
Basic32-9SF	0.35	0.75	1.2
Basic32-12SF	0.4	0.75	1.4
Basic40-4.5SF	0.45	0.85	1.55
Basic40-6SF	0.5	0.9	1.6
Basic40-8SF	85 C/0.6	0.75	1.5
Basic 40-12SF Pro (230V)	0.35	0.75	1.15
Basic 40-12SF Pro(380V)	0.35	0.75	1.15
Basic 40-16SF Pro(230V)	0.4	0.75	1.4
Basic 40-16SF Pro(380V)	0.4	0.75	1.4
Basic 50-12SF Pro(230V)	0.4	0.75	1.4
Basic 50-12SF Pro(380V)	0.4	0.75	1.4
Basic 50-16SF Pro(230V)	0.35	0.75	1.35
Basic 50-16SF Pro(380V)	0.35	0.75	1.35
Basic 50-20SF Pro(380V)	0.85	1	1.6
Basic 65-8SF Pro(230V)	0.45	0.75	1.2
Basic 65-8SF Pro(380V)	0.45	0.75	1.2
Basic 65-12SF Pro(230V)	0.7	1	1.7
Basic 65-12SF Pro(380V)	0.7	1	1.7
Basic 65-15SF (380V)	0.4	0.75	1.4
Basic 65-18SF (380V)	0.4	0.75	1.4
Basic 80-8SF (230V)	0.65	1.1	1.7
Basic 80-8SF (380V)	0.65	1.1	1.7
Basic 80-10SF Pro(230V)	0.65	1.1	1.7
Basic 80-10SF Pro(380V)	0.65	1.1	1.7
Basic 80-12SF Pro(380V)	0.65	1.1	1.7
Basic25-9Z	0.4	0.8	1.5
Basic25-12Z	0.4	0.8	1.5
Basic20-12SZ	0.4	0.75	1.5
Basic20-16SZ	0.4	0.75	1.5
Basic25-16Z	0.4	0.8	1.5
Basic25-20Z	0.4	0.8	1.5
Basic20-20Z	0.4	0.8	1.5
Basic20-26Z	0.4	0.8	1.5
Basic20-35Z	0.4	0.8	1.55

Sound pressure

Sound pressure depends on the power consumed:
 $\leq 45 \text{ dB(A)}$ for models with $P1 \leq 250\text{W}$
 $\leq 48 \text{ dB(A)}$ for models with $250\text{W} < P1 \leq 1,000\text{W}$
 $\leq 54 \text{ dB(A)}$ for models with $P1 > 1,000\text{W}$

Installation

The pump should be installed with the motor shaft in a horizontal position.

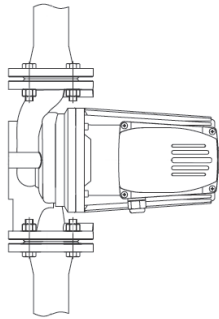

Fig. 16 Motor shaft position

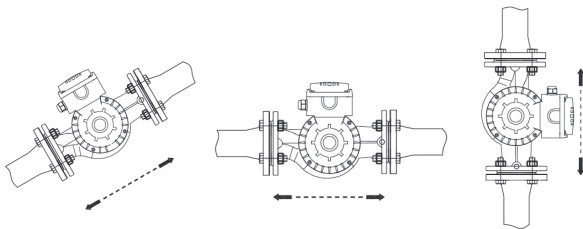

Fig. 17 Possible positions of the terminal box

External impulse switch

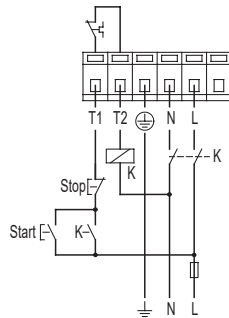

Fig. 18 Single phase

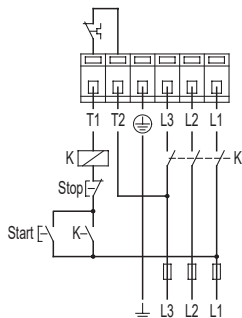

Fig. 19 Three-phase without a neutral wire

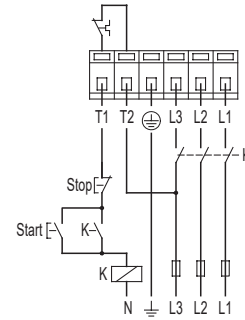

Fig. 20 Three-phase with a neutral wire

Electrical connection

The pump must be connected to the mains via an external contactor. The switch should be connected to an integrated heat relay of the pump designed to protect the motor from overload in each of the three rotational frequency ranges.

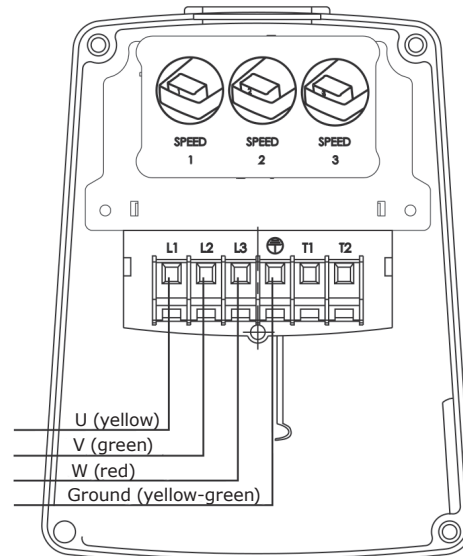

Fig. 21 Mode of frequency switch

Electrical data

Supply voltage and current frequency	1 x 220-240 V, 50 Hz 3 x 400-415 V, 50 Hz
Motor protection	External protection is required
Enclosure class	IP44
Insulation class	H

Electric equipment should be connected and protection should be installed according to local regulations and rules.

Earthing or neutralization can be connected in order to protect from an accidental touch. As an additional protection, you can use a current- or voltage-operated earth-leakage circuit breaker. Never perform any connections in the terminal box when the power is on.

The pump must be earthed and connected to an external mains switch.

Operation voltage and frequency are written on a pump nameplate with rated electric data. Make sure that the motor parameters comply with the power supply it will be connected to.

The pump should be connected to power supply via an external contactor. T1 and T2 outputs of a built-in thermal switch that the pumps with a motor of 300 W and above have should be involved in the starter coil break.

Caution: if the pump motor is protected with a motor starter, then the starter should be adjusted for a maximum consumed current during operation at a certain frequency. The motor starter setting must be changed every time the pump speed is changed. Current values consumed at different frequency are written on a pump nameplate of the pump.

Construction

Basic pumps are of the canned rotor type, i.e. the pump and motor form a single unit without shaft seal. This unit requires only two sealing rings and the bearings are lubricated with pumped liquid.

Advantages of BASIC pumps design:

- Single or three-speed motor.
- Ceramic radial bearings.
- Carbon thrust bearing.
- A protective rotor can, external rotor cover, and bearing plate are made of stainless steel.
- Cast iron pump housing.
- Thermal switch integrated in the stator coil, for motors from 300 W.

Product range

Pump model	Connection size	Port-to-port length, mm	Rated flow, (m³/h)	Rated head, (m)	Rated power, (W)	Rated current, (A)	Voltage	
							230V	380V
Basic15-9S	3/4"-1/2"	130	0.7	6	120/80/65	0.5/0.4/0.3	•	
Basic15-12S	3/4"-1/2"	150	2	9.5	270/240/160	1.2/1.1/0.75	•	
Basic20-12S	1"-3/4"	180	2	9	270/240/160	1.2/1.1/0.75	•	
Basic25-12S	1 1/2"-1"	180	2	9	270/240/160	1.2/1.1/0.75	•	
Basic25-9S	1 1/2"-1"	180/220	4	6.3	300/280/260	1.5/1.4/1.3	•	
Basic32-9S	2"-1 1/4"	180/220	5	6.5	300/280/260	1.5/1.4/1.3	•	
Basic25-12SL	1 1/2"-1"	200	3.5	9	300/280/260	1.5/1.4/1.3	•	
Basic25-12S(500W)	1 1/2"-1"	180/220	5	8	500/460/440	2.5/2.3/2.0	•	
Basic32-12S	2"-1 1/4"	180/220	6	8	500/460/440	2.5/2.3/2.0	•	
Basic25-16	1 1/2"-1"	230	5	12.5	700	3.4	•	
Basic25-20	1 1/2"-1"	230	8	16	1000	4.9	•	
Basic32-8SF	DN32	200	4	5.5	245	1.1	•	
Basic32-9SF	DN32	220	5	7	300/280/260	1.5/1.4/1.3	•	
Basic32-12SF	DN32	220	5	9	500/460/440	2.5/2.3/2.0	•	
Basic40-4.5SF	DN40	230/250	8	3.2	300/280/260	1.5/1.4/1.3	•	
Basic40-6SF	DN40	230/250	12.5	4.2	500/460/440	2.5/2.3/2.0	•	
Basic40-8SF	DN40	250	4	5.5	245/190/135	1.10/0.85/0.60	•	
Basic 40-12SF Pro (230V)	DN40	250	8	10.7	700/550/410	3.4/2.4/1.8	•	
Basic 40-12SF Pro(380V)	DN40	250	8	10.7	700/580/500	2.05/1.03/0.87		•
Basic 40-16SF Pro(230V)	DN40	250	8	13.5	1000/860/580	4.9/3.8/2.6	•	
Basic 40-16SF Pro(380V)	DN40	250	8	13.5	1000/770/670	2.3/1.3/1.2		•
Basic 50-12SF Pro(230V)	DN50	280	16	8	1000/860/580	4.9/3.8/2.6	•	
Basic 50-12SF Pro(380V)	DN50	280	16	8	1000/770/670	2.3/1.3/1.2		•
Basic 50-16SF Pro(230V)	DN50	280	16	12	1300/1100/800	5.8/4.9/3.5	•	
Basic 50-16SF Pro(380V)	DN50	280	16	12	1300/1000/930	3.05/1.75/1.6		•
Basic 50-20SF Pro(380V)	DN50	280	16	13.7	1500/1250/1100	3.5/2.05/1.85		•
Basic 65-8SF Pro(230V)	DN65	340	20	4.2	700/550/410	3.4/2.4/1.8	•	
Basic 65-8SF Pro(380V)	DN65	340	20	4.2	700/580/500	2.05/1.03/0.87		•
Basic 65-12SF Pro(230V)	DN65	340	20	10.7	1300/1100/800	5.8/4.9/3.5	•	
Basic 65-12SF Pro(380V)	DN65	340	20	10.7	1300/1000/930	3.05/1.75/1.6		•
Basic 65-15SF (380V)	DN65	340	20	12	1500/1250/1100	3.5/2.05/1.85		•
Basic 65-18SF (380V)	DN65	340	24	10.5	1800/1450/1350	3.6/2.37/2.27		•
Basic 80-8SF (230V)	DN80	360	25	5	1000/860/580	4.9/3.8/2.6	•	
Basic 80-8SF (380V)	DN80	360	25	5	1000/770/670	2.3/1.3/1.2		•
Basic 80-10SF Pro(230V)	DN80	360	25	8	1300/1100/800	5.8/4.9/3.5	•	
Basic 80-10SF Pro(380V)	DN80	360	25	8	1300/1000/930	3.05/1.75/1.6		•
Basic 80-12SF Pro(380V)	DN80	360	25	10	1500/1250/1100	3.5/2.05/1.85		•
Basic25-9Z	DN25	110	4	7	300	1.5	•	
Basic25-12Z	DN25	110	5	8	500	2.5	•	
Basic20-12SZ	DN20	106	3	10	300/280/260	1.5/1.4/1.3	•	
Basic20-16SZ	DN20	106	3	13	500/460/440	2.5/2.3/2.0	•	
Basic25-16Z	DN20	130	5	12.5	700	3.4	•	
Basic25-20Z	DN20	130	8	15.2	1000	4.9	•	
Basic20-20Z	DN20	140	5	16	700	2.5	•	
Basic20-26Z	DN20	140	6	20	1000	4.9	•	
Basic20-35Z	DN20	140	7	22	1300	5.8	•	

Performance curves and technical data

Basic 15-9S

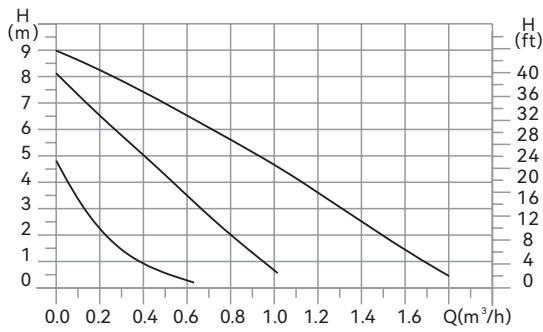

Basic 15-12S

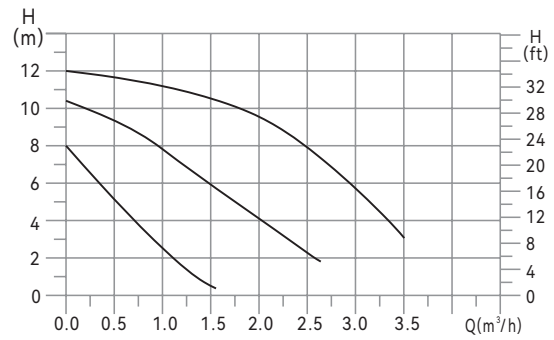

Basic 20-12S

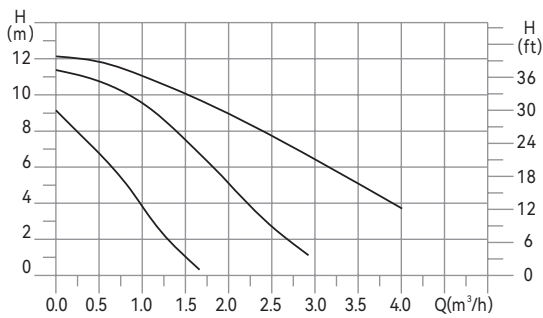

Basic 25-12S

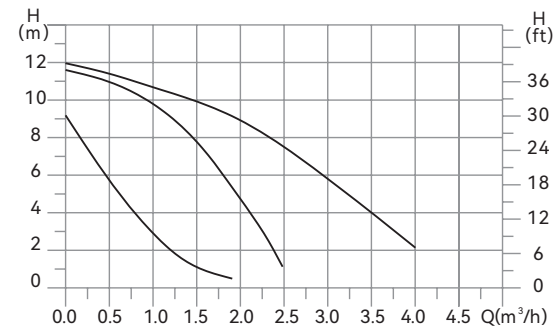

Basic 25-9S

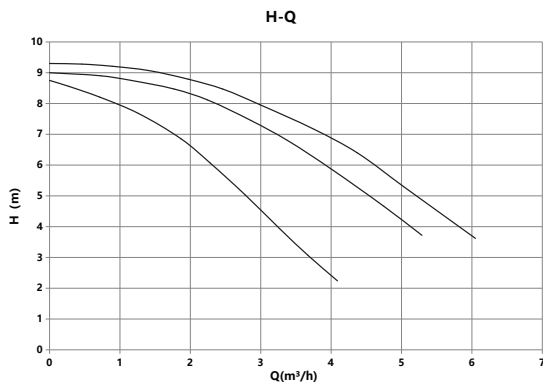

Basic 32-9S

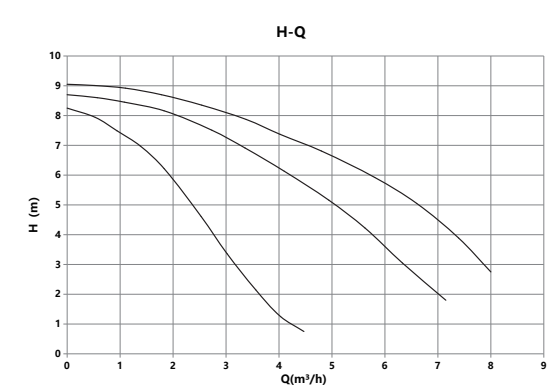

Basic 25-12S (500W)

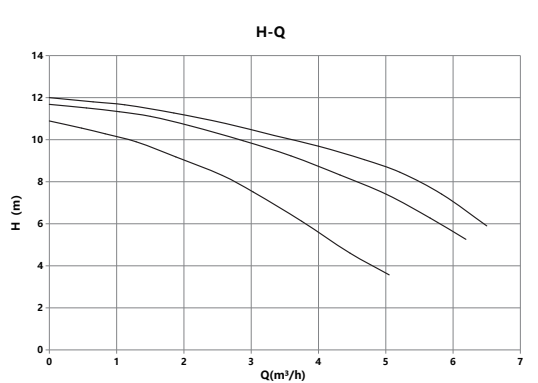

Basic 25-12SL

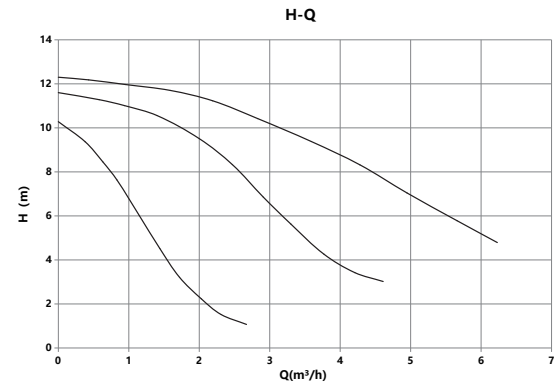

Performance curves and technical data

Basic 32-12S

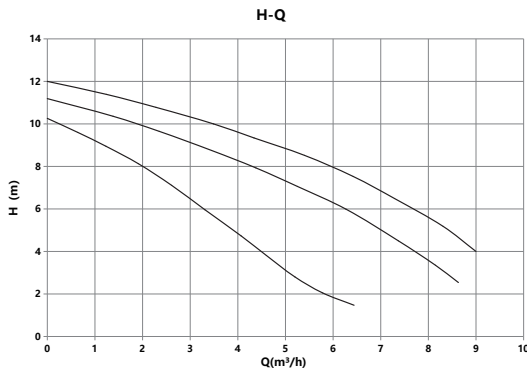

Basic 25-16

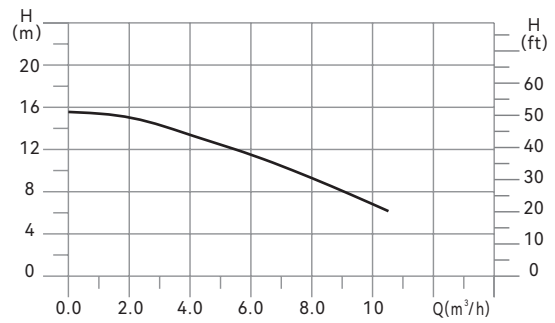

Basic 25-20

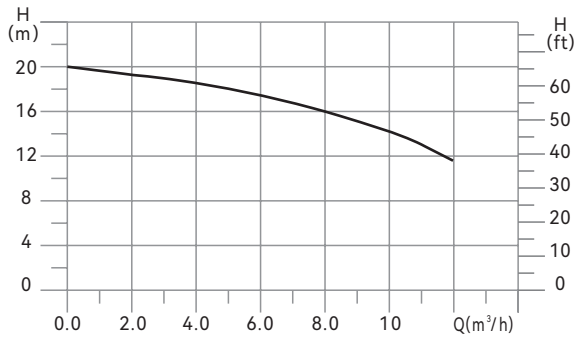

Basic 32-8SF

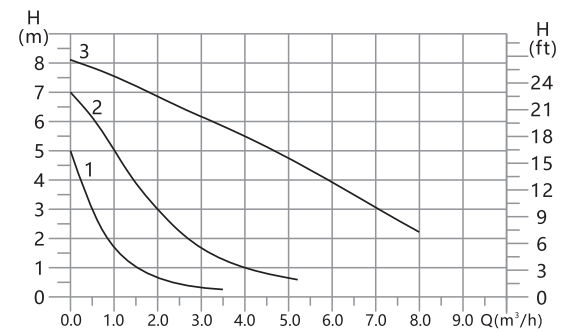

Basic 32-9SF

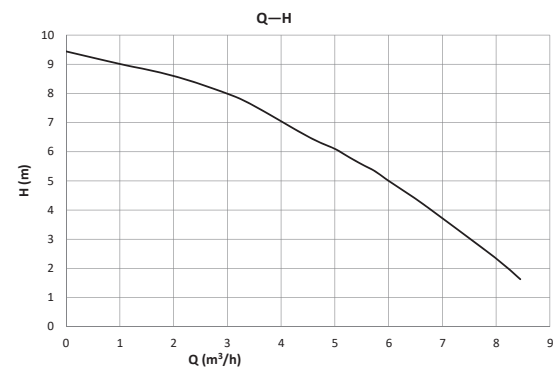

Basic 32-12SF

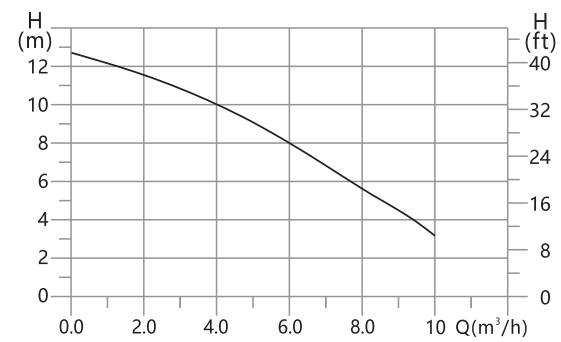

Basic 40-4.5SF

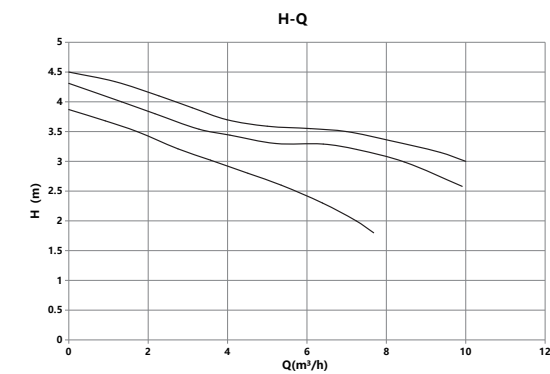

Basic 40-6SF

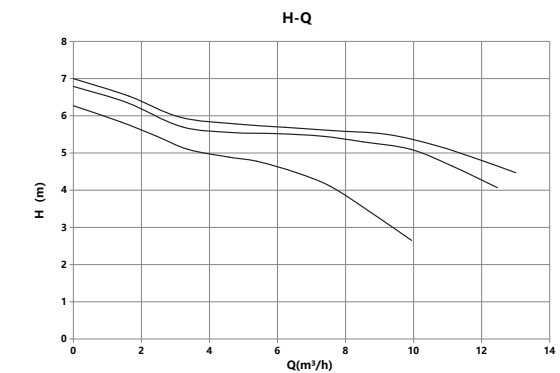

Basic 40-8SF

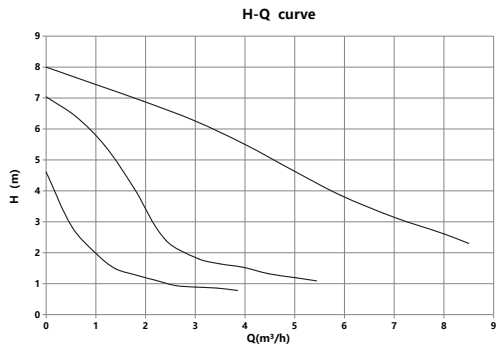

Basic 40-12SF Pro (230V)

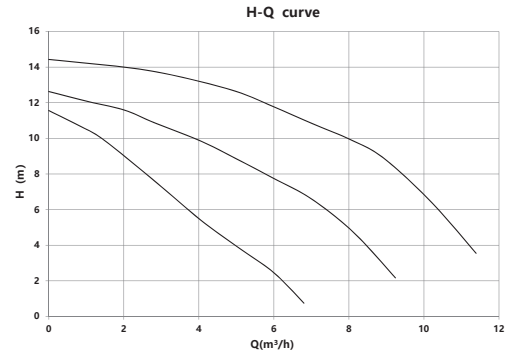

Basic 40-12SF Pro (380V)

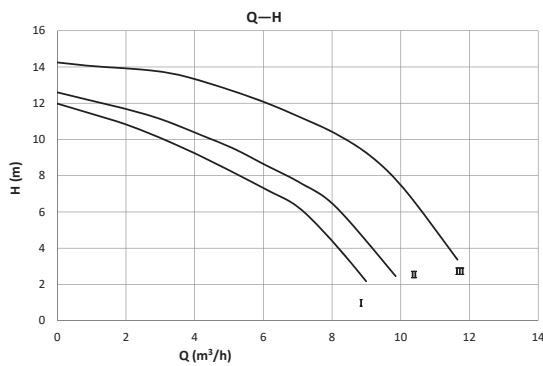

Basic 40-16SF Pro (230V)

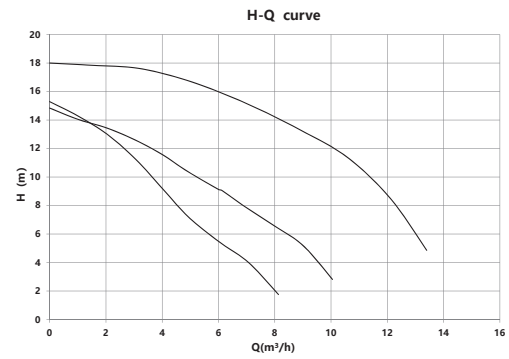

Basic 40-16SF Pro (380V)

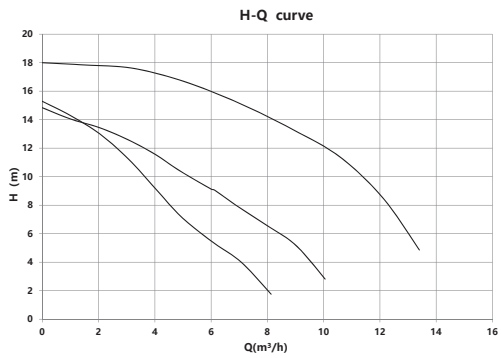

Basic 50-12SF Pro (230V)

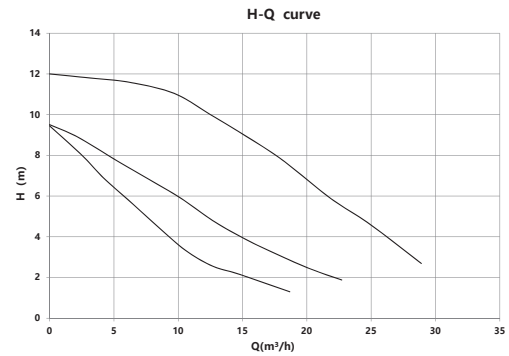

Basic 50-12SF Pro (380V)

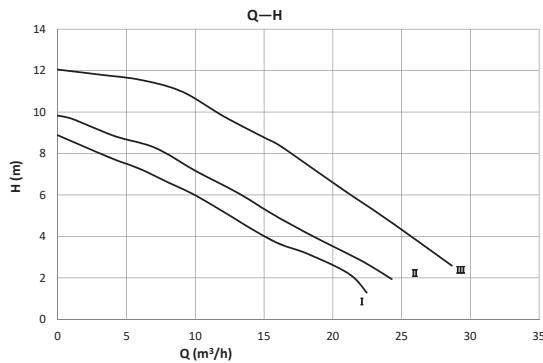

Basic 50-16SF Pro (230V)

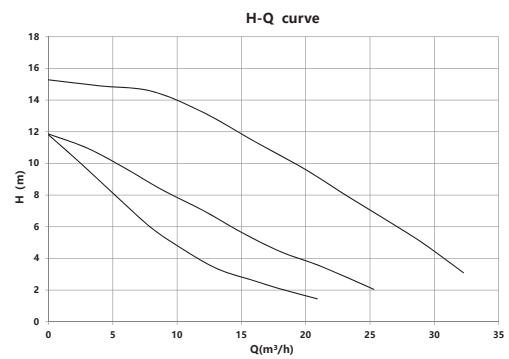

Basic 50-20SF Pro (380V)

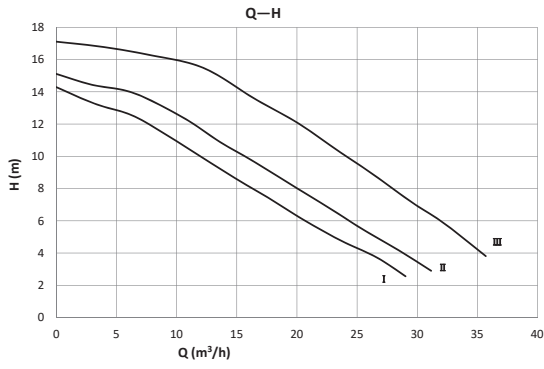

Basic 50-16SF Pro (380V)

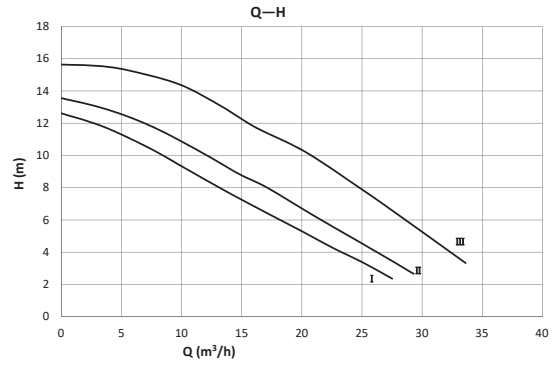

Basic 65-8SF Pro (230V)

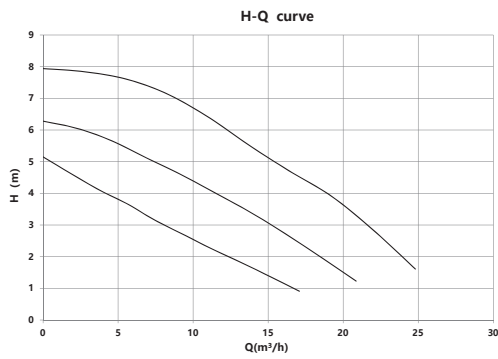

Basic 65-8SF Pro (380V)

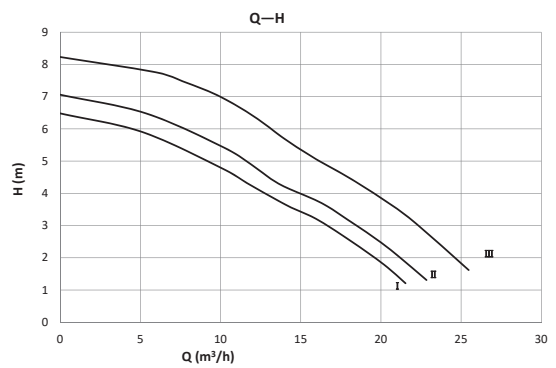

Basic 65-12SF Pro (230V)

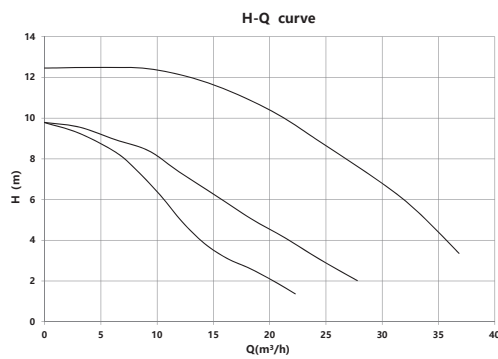

Basic 65-12SF Pro (380V)

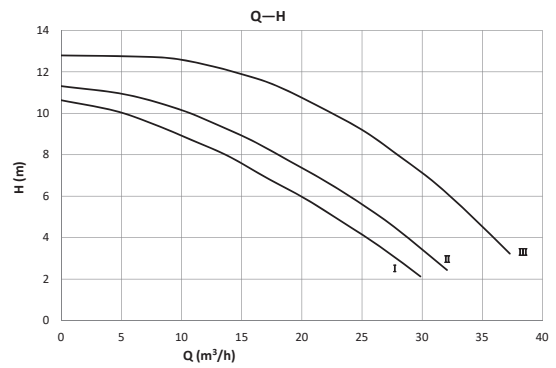

Basic 65-15SF (380V)

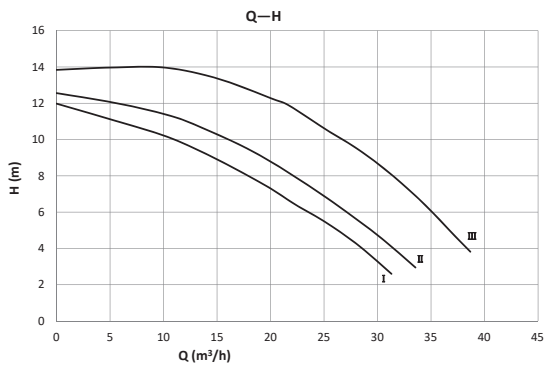

Basic 65-18SF (380V)

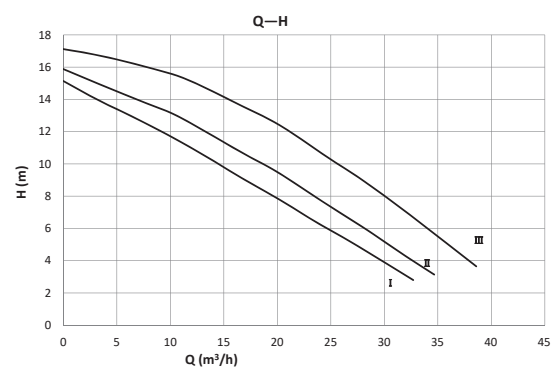

Basic 80-8SF(230V)

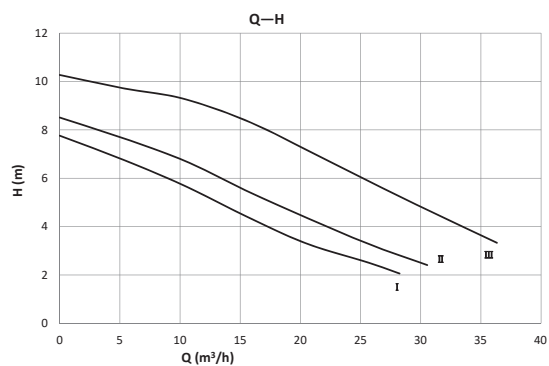

Basic 80-8SF Pro (380V)

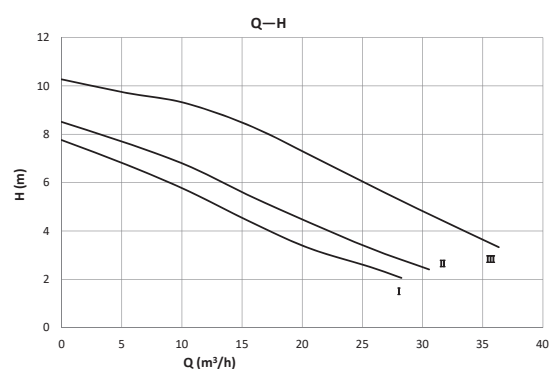

Basic 80-10SF Pro (230V)

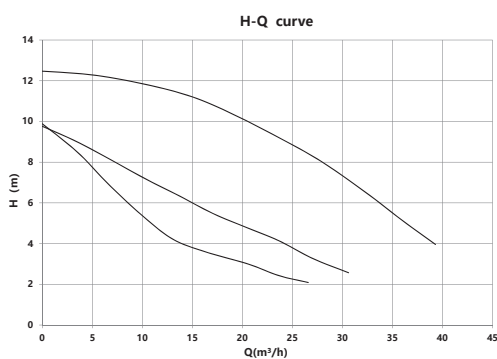

Basic 80-10SF Pro (380V)

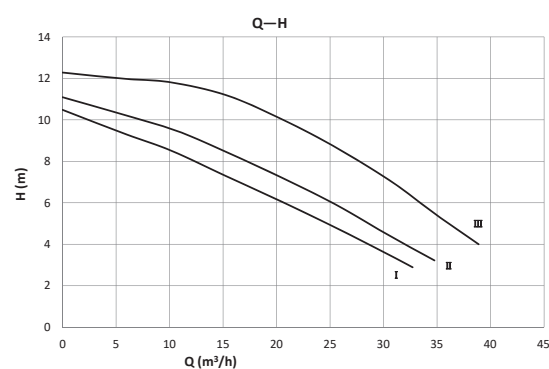

Basic 80-12SF Pro (380V)

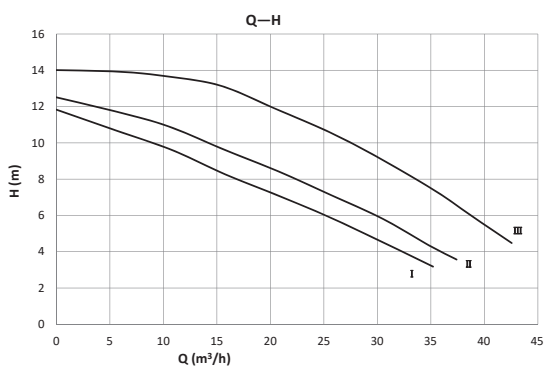

Basic 25-9Z

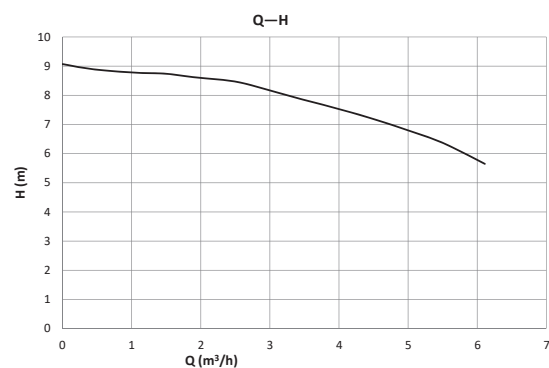

Basic 20-12SZ

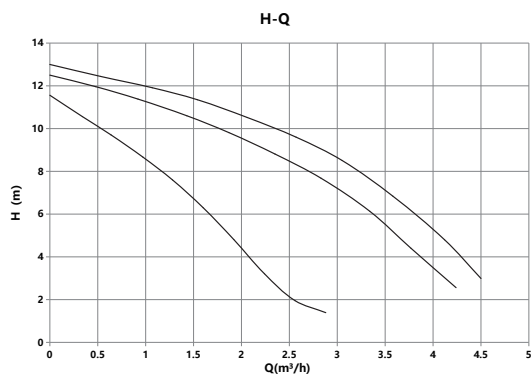

Basic 25-12Z

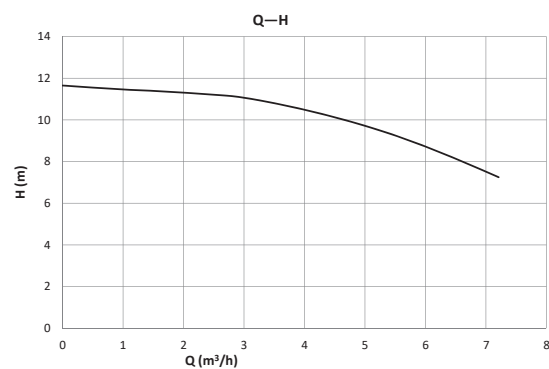

Basic 20-16SZ

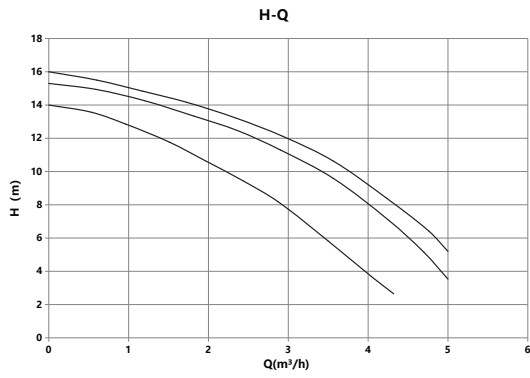

Basic 25-16Z

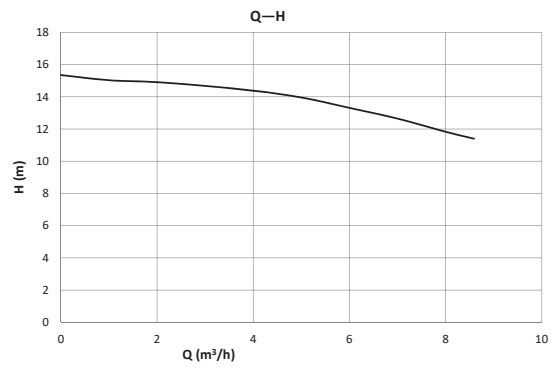

Basic 20-20Z

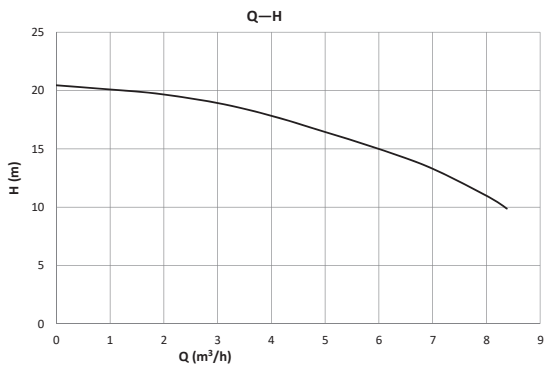

Basic 25-20Z

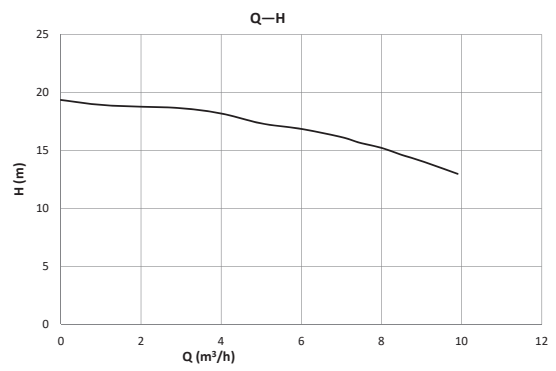

Basic 20-26Z

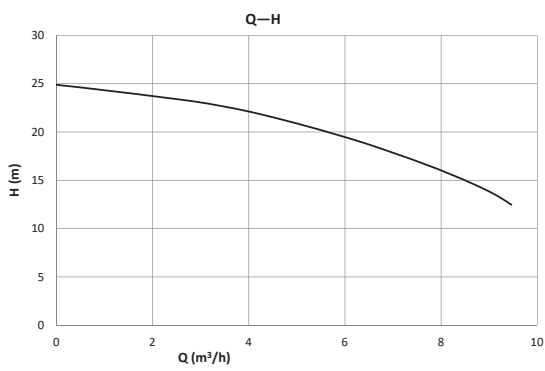

Basic 20-35Z

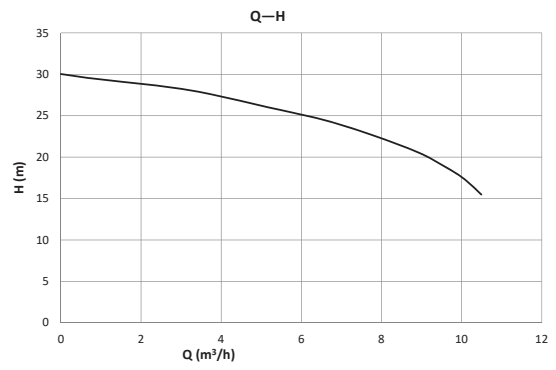

Dimensions

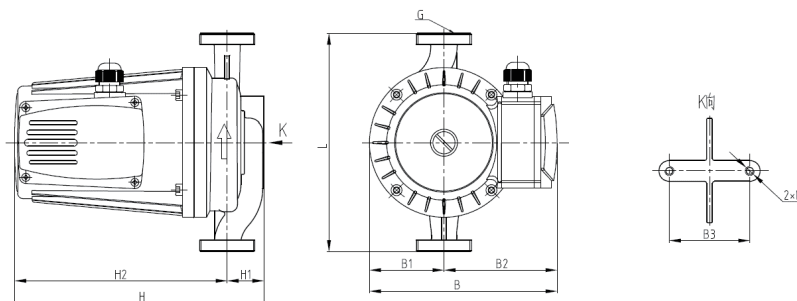

Pump model	L	B	B1	B2	B3	H	H1	H2	M	G[inch]
Basic25-9S	180	167	68	99	70	209	44	165	M8	1 1/2"
Basic32-9S	220	167	68	99	70	209	44	165	M8	1 1/4"
Basic25-12SL	180	167	68	99	70	214	49	165	M8	2"
Basic25-12S(500W)	220	167	68	99	70	214	49	165	M8	2"
Basic32-12S	180	167	68	99	70	229	44	185	M8	1 1/2"
Basic25-16	220	167	68	99	70	229	44	185	M8	1 1/4"
Basic25-20	200	164	65	99	70	207	45	162	M8	1 1/2"

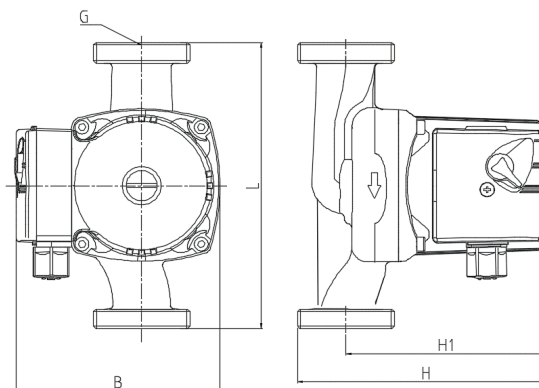

Pump model	L	B	H	H1	G[inch]
Basic15-9S	130	130	130	105	3/4"
Basic15-12S	150	130	130	105	3/4"
Basic20-12S	180	150	151	128	1"
Basic25-12S	180	150	151	128	1 1/2"

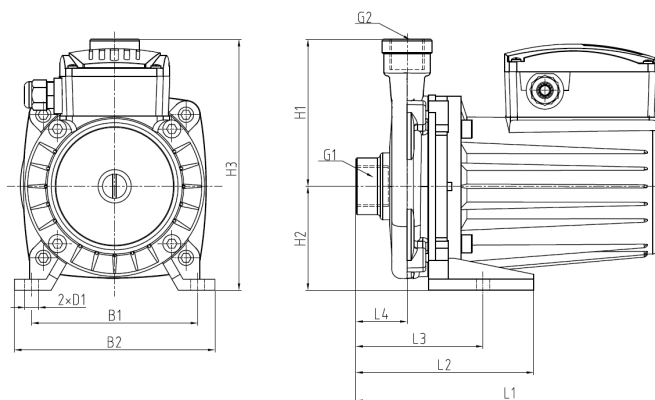

Pump model	H1	H2	H3	L1	L2	L3	L4	B1	B2	D1	G1[inch]	G2[inch]
Basic25-9Z	110	72	182	209	130	114	45	104	132	9.5	1 1/4"	1"
Basic25-12Z	110	72	182	229	130	114	45	104	132	9.5	1 1/4"	1"
Basic20-12SZ	106	75	181	202	128	92	37	120	145	10	1"	3/4"
Basic20-16SZ	106	75	181	222	128	92	37	120	145	10	1"	3/4"
Basic25-16Z	130	93	244	268	165	148	48	134	164	12	1 1/4"	1"
Basic25-20Z	130	93	244	268	165	148	48	134	164	12	1 1/4"	1"
Basic20-20Z	140	95	249	272	162	116	43	154	185	12	1"	3/4"
Basic20-26Z	140	95	249	272	162	116	43	154	185	12	1"	3/4"
Basic20-35Z	140	95	249	297	162	116	43	154	185	12	1"	3/4"

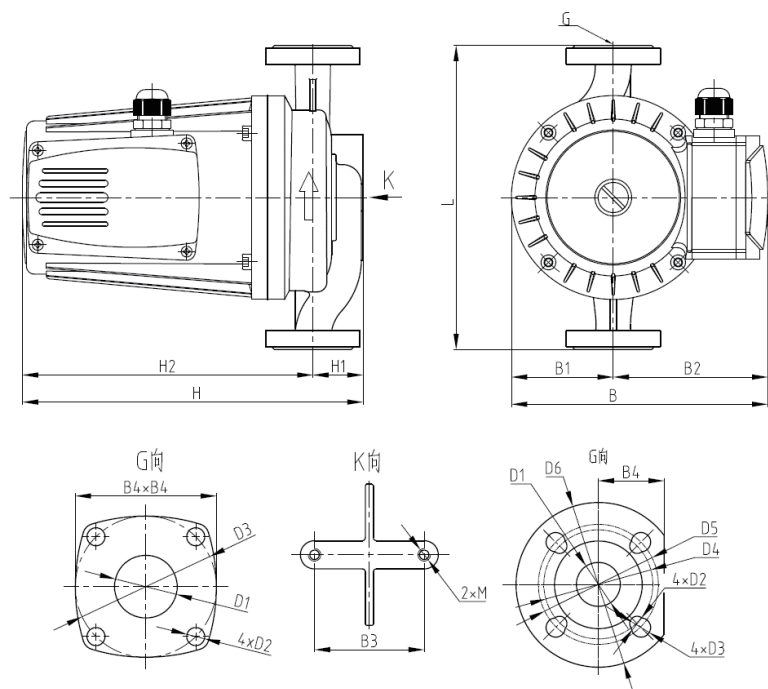

Pump model	Pump dimensions [mm]								Flange dimensions [mm]							Connection	
	L	H	H1	H2	B	B1	B2	B3	B4	D1	D2	D3	D4	D5	D6	M	DN
Basic32-8SF	200	185	55	130	150	/	/	/	/	32	11.5	/	/	/	/	M8	DN32
Basic32-9SF	220	214	49	165	167	68	99	90	70	40	11.5	90	/	/	/	M8	DN32
Basic32-12SF	220	234	49	185	167	68	99	90	70	40	11.5	90	/	/	/	M8	DN32
Basic40-4.5SF	230	235	60	175	167	68	99	90	60	40	13.5	17.5	100	110	150	M8	DN40
	250	240	68	172	167	68	99	90	60	40	14	19	100	110	150	M8	DN40
Basic40-6SF	230	255	60	195	167	68	99	90	60	40	13.5	17.5	100	110	150	M8	DN40
	250	260	68	192	167	68	99	90	60	40	14	19	100	110	150	M8	DN40
Basic40-8SF	250	180	60	120	160	75	85	/	/	40	13.5	17.5	100	110	150	/	DN40
Basic 40-12SF (230V)	250	303	73	230	243	86	157	80	64	40	17.5	13.5	110	100	150	M10	DN40
Basic 40-12SF(380V)	250	303	73	230	243	86	157	80	64	40	17.5	13.5	110	100	150	M10	DN40
Basic 40-16SF(230V)	250	303	73	230	243	86	157	80	64	40	17.5	13.5	110	100	150	M10	DN40
Basic 40-16SF(380V)	250	303	73	230	243	86	157	80	64	40	17.5	13.5	110	100	150	M10	DN40
Basic 50-12SF(230V)	280	320	73	246	254	97	157	90	70	50	17.5	13.5	125	110	165	M10	DN50
Basic 50-12SF(380V)	280	320	73	246	254	97	157	90	70	50	17.5	13.5	125	110	165	M10	DN50
Basic 50-16SF(230V)	280	346	73	273	254	97	157	90	70	50	17.5	13.5	125	110	165	M10	DN50
Basic 50-16SF(380V)	280	346	73	273	254	97	157	90	70	50	17.5	13.5	125	110	165	M10	DN50
Basic 50-20SF(380V)	280	366	73	293	254	97	157	90	70	50	17.5	13.5	125	110	165	M10	DN50
Basic 65-8SF(230V)	340	315	82	233	253	96	157	96	80	65	17.5	13.5	145	130	180	M10	DN65
Basic 65-8SF(380V)	340	315	82	233	253	96	157	96	80	65	17.5	13.5	145	130	180	M10	DN65
Basic 65-12SF(230V)	340	338	82	256	253	96	157	96	80	65	17.5	13.5	145	130	180	M10	DN65
Basic 65-12SF(380V)	340	338	82	256	253	96	157	96	80	65	17.5	13.5	145	130	180	M10	DN65
Basic 65-15SF(380V)	340	360	82	278	253	96	157	96	80	65	17.5	13.5	145	130	180	M10	DN65
Basic 65-18SF(380V)	340	359	82	277	267	100	167	90	80	65	17.5	13.5	145	130	180	M10	DN65
Basic 80-8SF(230V)	360	329	83	246	265	108	157	90	/	80	8*18	/	160	/	200	M10	DN80
Basic 80-8SF(380V)	360	329	83	246	265	108	157	90	/	80	8*18	/	160	/	200	M10	DN80
Basic 80-10SF(230V)	360	354	108	246	265	108	157	90	/	80	8*18	/	160	/	200	M10	DN80
Basic 80-10SF(380V)	360	354	108	246	265	108	157	90	/	80	8*18	/	160	/	200	M10	DN80
Basic 80-12SF(380V)	360	374	128	246	265	108	157	90	/	80	8*18	/	160	/	200	M10	DN80

Promo compact pressure booster pumps



Fig. 54 Promo

Type key

Example	Promo	15	-9	A
Type range	_____	_____	_____	_____
Nominal diameter of inlet and outlet ports (DN), [mm]	_____	_____	_____	_____
Maximum head [dm]	_____	_____	_____	_____
Automatic start/stop with flow relay	_____	_____	_____	_____

Application

PROMO pumps are designed to increase the pressure in the currently used water supply systems of private houses. First of all, they are used to generate head before heaters (gas-fired water heaters and direct-flow water heaters), washing machines and dishwashers. PROMO can also be used to increase water pressure in the shower or other points of water distribution.

PROMO pumps are used in open systems and can be directly connected with the water supply system. PROMO pumps are equipped with a built-in flow relay that is used for automatic turning on/off the pump when the tap is open in the water distribution point.

The pumps are available with cast iron housing with a cathaphoretic coating, impeller is made of composite material.

Operating conditions

Minimum inlet port pressure — 0.2 bar.

The pump should be placed in a non-aggressive and non-explosive environment.

Relative air humidity — not more than 95 %.

Technical data

Operation range	Feed up to 2.8 m ³ /h
Head	up to 12 m
Supply voltage	1 x 230 V
Liquid temperature	from 2 to +60 °C
Ambient temperature	from 2 to +40 °C
Max. operating pressure	6 bar
Connection of PROMO 15-9A	G 3/4"
Connection of PROMO 15-12A	G 3/4"

Pumped liquids

- clean water,
- chlorinated tap water.

The pump should not be used for pumping explosive liquids such as diesel fuel, petrol and other similar liquids.

Construction

These pumps are of the canned-rotor type, that is pump and motor form an integral unit without shaft seal. Only two gaskets are required for sealing. The bearings are lubricated by the pumped liquid. Thus, PROMO motor is cooled with pumped liquid and is not equipped with air fan, which allows it working silently. Due to a unique system of ceramic bearings, PROMO pumps are exclusively durable and reliable.

The pump is supplied with a cable with a Schuko plug. PROMO 15-9A motor is equipped with short circuit and full resistance protection. A motor of PROMO 15-12A is equipped with thermal overloading protection. In both cases, it is not necessary to have an additional external protection of the motor.

Enclosure class: IP43.

Insulation class: H.

Operating modes

I Off

II Automatic

The pump is automatically turned on via the flow relay when the flow is 2.5 l/min. If the flow is below these values, the pump automatically stops. It is important that the pump stops in this mode automatically if the water is not fed. Thus, it is protected from dry running.

III Manual

The pump works constantly with no regard to the flow relay.

Performance curves and technical data

PROMO 15-9A

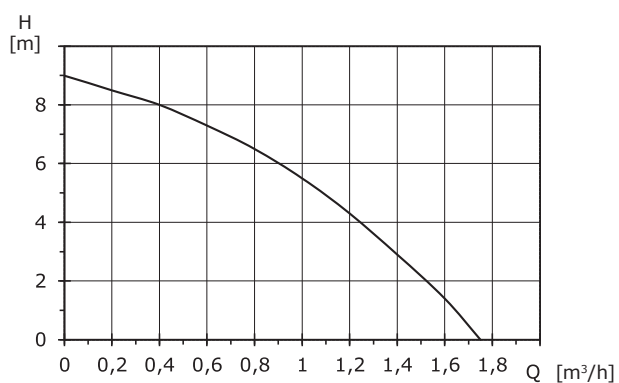

PROMO 15-12A

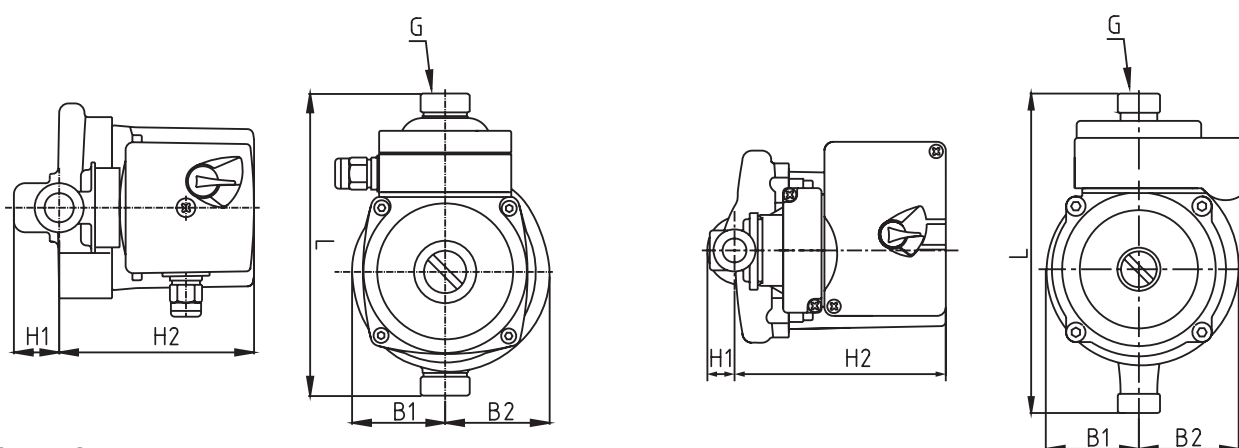
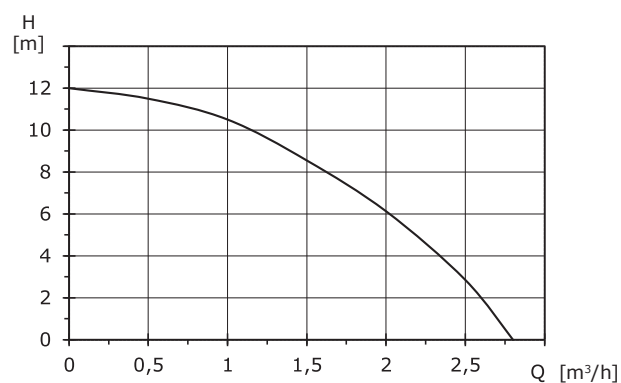

Dimensions

Product type	Size [mm]						Weight [kg]	
	L	H1	H2	B1	B2	G	Net weight	Gross weight
PROMO 15-9A	160	23	103	50	54	3/4"	2.5	2.7
PROMO 15-12A	200	18	132	63	69	3/4"	2.5	2.7

Electrical and technical parameters

Product type	P1 _{max.} [W]	I _{1/1} [A]
PROMO 15-9A	120	0.5
PROMO 15-12A	270	1.2

Anhui Shinhoo Canned Motor Pump Co., Ltd.

Address: No.780, Ming Chuan Road, High-Tech Zone,
Hefei, Anhui, P.R China

Tel.: +86-551-62379807

E-mail: info@shinhoodump.com

For information only. Technical modifications are possible.
All rights reserved.

shinhoodump.com